

CIGWELD

AN ESAB® BRAND

STICK

TIG



Art # A-12795_AB

WeldSkill 140 / 180

OPERATING MANUAL



140 Inverter



180 Inverter

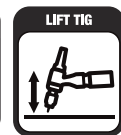
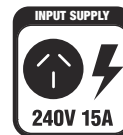



<http://warranties.cigweld.com.au>

Check out our online registration for the most up to date competitions and promotions



PROTECT YOUR INVESTMENT

Please register your warranty online immediately after purchase for complete warranty coverage and to guarantee your proof of purchase.



WE APPRECIATE YOUR BUSINESS!

Congratulations on your new CIGWELD product. We are proud to have you as our customer and will strive to provide you with the best service and reliability in the industry. This product is backed by our extensive warranty and world-wide service network. To locate your nearest distributor or accredited service provider call +1300 654 674, or visit us on the web at www.cigweld.com.au

This Operating Manual has been designed to instruct you on the correct use and operation of your CIGWELD product. Your satisfaction with this product and its safe operation is our ultimate concern. Therefore please take the time to read the entire manual, especially the Safety Precautions. They will help you to avoid potential hazards that may exist when working with this product.

We have made every effort to provide you with accurate instructions, drawings, and photographs of the product(s) while writing this manual. However errors do occur and we apologize if there are any contained in this manual.

Due to our constant effort to bring you the best products, we may make an improvement that does not get reflected in the manual. If you are ever in doubt about what you see or read in this manual with the product you received, then check for a newer version of the manual on our website or contact our customer support for assistance.

YOU ARE IN GOOD COMPANY!

The Brand of Choice for Contractors and Fabricators Worldwide.

CIGWELD is a Market Leading Brand of Arc Welding Products for ESAB. We are a mainline supplier to major welding industry sectors in the Asia Pacific and emerging global markets including; Manufacturing, Construction, Mining, Automotive, Engineering, Rural and DIY.

We distinguish ourselves from our competition through market-leading, dependable products that have stood the test of time. We pride ourselves on technical innovation, competitive prices, excellent delivery, superior customer service and technical support, together with excellence in sales and marketing expertise.

Above all, we are committed to develop technologically advanced products to achieve a safer working environment for industry operators.

**WARNINGS**

Read and understand this entire Manual and your employer's safety practices before installing, operating, or servicing the equipment.

While the information contained in this Manual represents the Manufacturer's best judgement, the Manufacturer assumes no liability for its use.

CIGWELD WeldSkill 140 and 180 Welding Inverters
Instruction Manual Number 0-5375 for:
Part Numbers W1008140, W1008180 and W1008181

Published by:
CIGWELD Pty Ltd
CIGWELD An ESAB Brand
71 Gower Street,
Preston, Victoria, Australia, 3072
+61 3 9474 7400 +61 3 9474 7391

www.cigweld.com.au

Copyright 2014
CIGWELD Pty Ltd

All rights reserved.

Reproduction of this work, in whole or in part, without written permission of the publisher is prohibited.

The publisher does not assume and hereby disclaims any liability to any party for any loss or damage caused by any error or omission in this Manual, whether such error results from negligence, accident, or any other cause.

For Printing Material Specification refer to document 47x1915.

Publication Date: May 7, 2015
Revision Date: July 24, 2015

Record the following information for Warranty purposes:

Where Purchased: _____

Purchase Date: _____

Equipment Serial #: _____

This Page Intentionally Blank

TABLE OF CONTENTS

SECTION 1:

ARC WELDING SAFETY INSTRUCTIONS AND WARNINGS	1-1
1.01 Arc Welding Hazards.....	1-1
1.02 PRINCIPAL SAFETY STANDARDS.....	1-5
1.03 DECLARATION OF CONFORMITY.....	1-6

SECTION 2:

INTRODUCTION	2-1
2.01 How To Use This Manual	2-1
2.02 Equipment Identification	2-1
2.03 Receipt Of Equipment	2-1
2.04 Symbol Chart.....	2-2
2.05 Description	2-3
2.06 User Responsibility.....	2-3
2.07 Packaged Item	2-3
2.08 Transporting Methods.....	2-4
2.09 Duty Cycle.....	2-4
2.10 Specifications	2-5
2.11 Optional Accessories	2-6
2.11 Optional Accessories (Cont'd)	2-7

SECTION 3:

INSTALLATION	3-1
3.01 Environment	3-1
3.02 Location.....	3-1
3.03 Ventilation.....	3-1
3.04 Mains Supply Voltage Requirements	3-1
3.05 Generators	3-1
3.06 Electromagnetic Compatibility	3-2

SECTION 4:

OPERATION	4-1
4.01 Overview	4-1
4.02 Power Source Controls, Indicators and Features	4-1

SECTION 5:

STICK (MMAW) WELDING	5-1
5.01 Setup For STICK (MMAW) Welding	5-1
5.02 Arc Welding Electrodes.....	5-2
5.03 Types of Electrodes.....	5-2
5.04 Size of Electrode	5-3
5.05 Storage of Electrodes.....	5-3
5.06 Electrode Polarity.....	5-3
5.07 Effects of Arc Welding Various Materials	5-4
5.08 Arc Welding Practice.....	5-4
5.09 Welding Position.....	5-4
5.10 Joint Preparations.....	5-5
5.11 Arc Welding Technique	5-6
5.12 The Welder.....	5-6
5.13 Striking the Arc	5-6
5.14 Arc Length	5-6
5.15 Rate of Travel.....	5-6

TABLE OF CONTENTS

5.16	Making Welded Joints.....	5-6
5.17	Distortion.....	5-9
5.18	The Cause of Distortion	5-9
5.19	Overcoming Distortion Effects	5-9
5.20	Welding Problems	5-11
SECTION 6:		
TIG (GTAW) WELDING.....		6-1
6.01	Shielding Gas Regulator/Flowmeter Operating Instructions.....	6-1
6.02	Setup For Lift TIG (GTAW) Welding	6-4
6.03	TIG (GTAW) Basic Welding Technique	6-5
6.04	TIG (GTAW) Welding Problems.....	6-7
SECTION 7:		
ROUTINE SERVICE REQUIREMENTS AND POWER SOURCE PROBLEMS		7-1
7.01	Routine Maintenance & Inspection	7-1
7.02	Cleaning the Welding Power Source	7-1
7.03	Basic Troubleshooting	7-1
7.04	Welding Power Source Problems	7-2
SECTION 8: KEY SPARE PARTS		8-1
8.01	WeldSkill 140 Key Spare Parts.....	8-1
8.02	WeldSkill 180 Key Spare Parts.....	8-2
CIGWELD - LIMITED WARRANTY TERMS		
WARRANTY SCHEDULE – WELDSKILL 140 & 180 INVERTERS		

SECTION 1: ARC WELDING SAFETY INSTRUCTIONS AND WARNINGS



WARNING

PROTECT YOURSELF AND OTHERS FROM POSSIBLE SERIOUS INJURY OR DEATH. KEEP CHILDREN AWAY. PACEMAKER WEARERS KEEP AWAY UNTIL CONSULTING YOUR DOCTOR. DO NOT LOSE THESE INSTRUCTIONS. READ OPERATING/INSTRUCTION MANUAL BEFORE INSTALLING, OPERATING OR SERVICING THIS EQUIPMENT.

Welding products and welding processes can cause serious injury or death, or damage to other equipment or property, if the operator does not strictly observe all safety rules and take precautionary actions.

Safe practices have developed from past experience in the use of welding and cutting. These practices must be learned through study and training before using this equipment. Some of these practices apply to equipment connected to power lines; other practices apply to engine driven equipment. Anyone not having extensive training in welding and cutting practices should not attempt to weld.

Safe practices are outlined in the Australian Standard AS1674.2-2007 entitled: Safety in welding and allied processes Part 2: Electrical. This publication and other guides to what you should learn before operating this equipment are listed at the end of these safety precautions. **HAVE ALL INSTALLATION, OPERATION, MAINTENANCE, AND REPAIR WORK PERFORMED ONLY BY QUALIFIED PEOPLE.**

1.01 Arc Welding Hazards



WARNING

ELECTRIC SHOCK can kill.

Touching live electrical parts can cause fatal shocks or severe burns. The electrode and work circuit is electrically live whenever the output is on. The input power circuit and machine internal circuits are also live when power is on. In semiautomatic or automatic wire welding, the wire, wire reel, drive roll housing, and all metal parts touching the welding wire are electrically live. Incorrectly installed or improperly grounded equipment is a hazard.

1. Do not touch live electrical parts.
2. Wear dry, hole-free insulating gloves and body protection.
3. Insulate yourself from work and ground using dry insulating mats or covers.
4. Disconnect input power or stop engine before installing or servicing this equipment. Lock input power disconnect switch open, or remove line fuses so power cannot be turned on accidentally.
5. Properly install and ground this equipment according to its Owner's Manual and national, state, and local codes.
6. Turn off all equipment when not in use. Disconnect power to equipment if it will be left unattended or out of service.
7. Use fully insulated electrode holders. Never dip holder in water to cool it or lay it down on the ground or the work surface. Do not touch holders connected to two welding machines at the same time or touch other people with the holder or electrode.
8. Do not use worn, damaged, undersized, or poorly spliced cables.
9. Do not wrap cables around your body.
10. Ground the workpiece to a good electrical (earth) ground.
11. Do not touch electrode while in contact with the work (ground) circuit.
12. Use only well-maintained equipment. Repair or replace damaged parts at once.
13. In confined spaces or damp locations, do not use a welder with AC output unless it is equipped with a voltage reducer. Use equipment with DC output.
14. Wear a safety harness to prevent falling if working above floor level.
15. Keep all panels and covers securely in place.

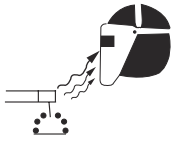

WARNING

*ARC RAYS can burn eyes and skin;
NOISE can damage hearing.*

Arc rays from the welding process produce intense heat and strong ultra-violet rays that can burn eyes and skin. Noise from some processes can damage hearing.

1. Use a Welding Helmet or Welding Faceshield fitted with a proper shade of filter (see ANSI Z49.1 and AS 1674 listed in Safety Standards) to protect your face and eyes when welding or watching.

2. Wear approved safety glasses. Side shields recommended.
3. Use protective screens or barriers to protect others from flash and glare; warn others not to watch the arc.
4. Wear protective clothing made from durable, flame-resistant material (wool and leather) and foot protection.
5. Use approved ear plugs or ear muffs if noise level is high.
6. Never wear contact lenses while welding.

Recommended Protective Filters for Electric Welding		
Description of Process	Approximate Range of Welding Current in Amps	Minimum Shade Number of Filter(s)
Manual Metal Arc Welding - covered electrodes (MMAW)	Less than or equal to 100	8
	100 to 200	10
	200 to 300	11
	300 to 400	12
	Greater than 400	13
Gas Metal Arc Welding (GMAW) (MIG) other than Aluminium and Stainless Steel	Less than or equal to 150	10
	150 to 250	11
	250 to 300	12
	300 to 400	13
	Greater than 400	14
Gas Metal Arc Welding (GMAW) (MIG) Aluminium and Stainless Steel	Less than or equal to 250	12
	250 to 350	13
Gas Tungsten Arc Welding (GTAW) (TIG)	Less than or equal to 100	10
	100 to 200	11
	200 to 250	12
	250 to 350	13
	Greater than 350	14
Flux-cored Arc Welding (FCAW) -with or without shielding gas.	Less than or equal to 300	11
	300 to 400	12
	400 to 500	13
	Greater than 500	14
Air - Arc Gouging	Less than or equal to 400	12
Plasma - Arc Cutting	50 to 100	10
	100 to 400	12
	400 to 800	14
Plasma - Arc Spraying	—	15
Plasma - Arc Welding	Less than or equal to 20	8
	20 to 100	10
	100 to 400	12
	400 to 800	14
Submerged - Arc Welding	—	2(5)
Resistance Welding	—	Safety Spectacles or eye shield

Refer to standard AS/NZS 1338.1:1992 for comprehensive information regarding the above table.

**WARNING**

FUMES AND GASES can be hazardous to your health.

Welding produces fumes and gases. Breathing these fumes and gases can be hazardous to your health.

1. Keep your head out of the fumes. Do not breathe the fumes.
2. If inside, ventilate the area and/or use exhaust at the arc to remove welding fumes and gases.
3. If ventilation is poor, use an approved air-supplied respirator.
4. Read the Material Safety Data Sheets (MSDSs) and the manufacturer's instruction for metals, consumables, coatings, and cleaners.
5. Work in a confined space only if it is well ventilated, or while wearing an air-supplied respirator. Shielding gases used for welding can displace air causing injury or death. Be sure the breathing air is safe.
6. Do not weld in locations near degreasing, cleaning, or spraying operations. The heat and rays of the arc can react with vapours to form highly toxic and irritating gases.
7. Do not weld on coated metals, such as galvanized, lead, or cadmium plated steel, unless the coating is removed from the weld area, the area is well ventilated, and if necessary, while wearing an air-supplied respirator. The coatings and any metals containing these elements can give off toxic fumes if welded.

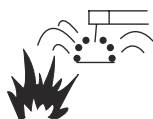
**WARNING**

WELDING can cause fire or explosion.

Sparks and spatter fly off from the welding arc. The flying sparks and hot metal, weld spatter, hot workpiece, and hot equipment can cause fires and burns. Accidental contact of electrode or welding wire to metal objects can cause sparks, overheating, or fire.

1. Protect yourself and others from flying sparks and hot metal.
2. Do not weld where flying sparks can strike flammable material.

3. Remove all flammables within 35 ft (10.7 m) of the welding arc. If this is not possible, tightly cover them with approved covers.
4. Be alert that welding sparks and hot materials from welding can easily go through small cracks and openings to adjacent areas.
5. Watch for fire, and keep a fire extinguisher nearby.
6. Be aware that welding on a ceiling, floor, bulkhead, or partition can cause fire on the hidden side.
7. Do not weld on closed containers such as tanks or drums.
8. Connect work cable to the work as close to the welding area as practical to prevent welding current from travelling long, possibly unknown paths and causing electric shock and fire hazards.
9. Do not use welder to thaw frozen pipes.
10. Remove stick electrode from holder or cut off welding wire at contact tip when not in use.

**WARNING**

FLYING SPARKS AND HOT METAL can cause injury.

Chipping and grinding cause flying metal. As welds cool, they can throw off slag.

1. Wear approved face shield or safety goggles. Side shields recommended.
2. Wear proper body protection to protect skin.

**WARNING**

CYLINDERS can explode if damaged.

Shielding gas cylinders contain gas under high pressure. If damaged, a cylinder can explode. Since gas cylinders are normally part of the welding process, be sure to treat them carefully.

1. Protect compressed gas cylinders from excessive heat, mechanical shocks, and arcs.
2. Install and secure cylinders in an upright position by chaining them to a stationary support or equipment cylinder rack to prevent falling or tipping.

3. Keep cylinders away from any welding or other electrical circuits.
4. Never allow a welding electrode to touch any cylinder.
5. Use only correct shielding gas cylinders, regulators, hoses, and fittings designed for the specific application; maintain them and associated parts in good condition.
6. Turn face away from valve outlet when opening cylinder valve.
7. Keep protective cap in place over valve except when cylinder is in use or connected for use.
8. Read and follow instructions on compressed gas cylinders, associated equipment, and CGA publication P-1 listed in Safety Standards.

**WARNING**

MOVING PARTS can cause injury.

Moving parts, such as fans, rotors, and belts can cut fingers and hands and catch loose clothing.

1. Keep all doors, panels, covers, and guards closed and securely in place.
2. Stop engine before installing or connecting unit.
3. Have only qualified people remove guards or covers for maintenance and troubleshooting as necessary.
4. To prevent accidental starting during servicing, disconnect negative (-) battery cable from battery.
5. Keep hands, hair, loose clothing, and tools away from moving parts.
6. Reinstall panels or guards and close doors when servicing is finished and before starting engine.

**WARNING**

This product, when used for welding or cutting, produces fumes or gases which contain chemicals known to the State of California to cause birth defects and, in some cases, cancer. (California Health & Safety code Sec. 25249.5 et seq.)

NOTE

Considerations About Welding And The Effects of Low Frequency Electric and Magnetic Fields

The following is a quotation from the General Conclusions Section of the U.S. Congress, Office of Technology Assessment, Biological Effects of Power Frequency Electric & Magnetic Fields - Background Paper, OTA-BP-E-63 (Washington, DC: U.S. Government Printing Office, May 1989): "...there is now a very large volume of scientific findings based on experiments at the cellular level and from studies with animals and people which clearly establish that low frequency magnetic fields and interact with, and produce changes in, biological systems. While most of this work is of very high quality, the results are complex. Current scientific understanding does not yet allow us to interpret the evidence in a single coherent framework. Even more frustrating, it does not yet allow us to draw definite conclusions about questions of possible risk or to offer clear science-based advice on strategies to minimize or avoid potential risks."

To reduce magnetic fields in the workplace, use the following procedures.

1. Keep cables close together by twisting or taping them.
2. Arrange cables to one side and away from the operator.
3. Do not coil or drape cable around the body.
4. Keep welding power source and cables as far away from body as practical.

**ABOUT PACEMAKERS:**

The above procedures are among those also normally recommended for pacemaker wearers. Consult your doctor for complete information.

1.02 PRINCIPAL SAFETY STANDARDS

Safety in Welding and Cutting, ANSI Standard Z49.1, from American Welding Society, 550 N.W. LeJeune Rd., Miami, FL 33126.

Safety and Health Standards, OSHA 29 CFR 1910, from Superintendent of Documents, U.S. Government Printing Office, Washington, D.C. 20402.

Recommended Safe Practices for the Preparation for Welding and Cutting of Containers That Have Held Hazardous Substances, American Welding Society Standard AWS F4.1, from American Welding Society, 550 N.W. LeJeune Rd., Miami, FL 33126.

National Electrical Code, NFPA Standard 70, from National Fire Protection Association, Batterymarch Park, Quincy, MA 02269.

Safe Handling of Compressed Gases in Cylinders, CGA Pamphlet P-1, from Compressed Gas Association, 1235 Jefferson Davis Highway, Suite 501, Arlington, VA 22202.

Code for Safety in Welding and Cutting, CSA Standard W117.2, from Canadian Standards Association, Standards Sales, 178 Rexdale Boulevard, Rexdale, Ontario, Canada M9W 1R3.

Safe Practices for Occupation and Educational Eye and Face Protection, ANSI Standard Z87.1, from American National Standards Institute, 1430 Broadway, New York, NY 10018.

Cutting and Welding Processes, NFPA Standard 51B, from National Fire Protection Association, Batterymarch Park, Quincy, MA 02269.

Safety in welding and allied processes Part 1: Fire Precautions, AS 1674.1-1997 from SAI Global Limited, www.saiglobal.com.

Safety in welding and allied processes Part 2: Electrical, AS 1674.2-2007 from SAI Global Limited, www.saiglobal.com.

Filters for eye protectors - Filters for protection against radiation generated in welding and allied operations AS/NZS 1338.1:1992 from SAI Global Limited, www.saiglobal.com.

1.03 DECLARATION OF CONFORMITY

Manufacturer: CIGWELD
Address: 71 Gower St, Preston
Victoria 3072

Australia

Description of equipment: Welding Equipment (MMAW, GTAW) including, but not limited to CIGWELD Weldskill 140, 180 inverters and associated accessories.

Serial numbers are unique with each individual piece of equipment and details description, parts used to manufacture a unit and date of manufacture.

The equipment conforms to all applicable aspects and regulations of the 'Low Voltage Directive' (Directive 2006/95/EC) and to the National legislation for the enforcement of the Directive.

National Standard and Technical Specifications

The product is designed and manufactured to a number of standards and technical requirements among them are:

- IEC 60974-10 applicable to Industrial Equipment - generic emissions and regulations.
- AS 60974.1 / IEC 60974-1 applicable to welding equipment and associated accessories.

Extensive product design verification is conducted at the manufacturing facility as part of the routine design and manufacturing process, to ensure the product is safe and performs as specified. Rigorous testing is incorporated into the manufacturing process to ensure the manufactured product meets or exceeds all design specifications.

CIGWELD has been manufacturing and merchandising an extensive equipment range with superior performance, ultra safe operation and world class quality for more than 30 years and will continue to achieve excellence.

SECTION 2: INTRODUCTION

2.01 How To Use This Manual

This Owners Manual only applies to the Part Numbers listed on page i.

To ensure safe operation, read the entire manual, including the chapter on safety instructions and warnings.

Throughout this manual, the words WARNING, CAUTION, and NOTE may appear. Pay particular attention to the information provided under these headings. These special annotations are easily recognized as follows:



WARNING

Gives information regarding possible personal injury. Warnings will be enclosed in a box such as this.



CAUTION

Refers to possible equipment damage. Cautions will be shown in bold type.

NOTE

Offers helpful information concerning certain operating procedures. Notes will be shown in italics.

Additional copies of this manual may be purchased by contacting CIGWELD at the address and phone number for your location listed in the inside back cover of this manual. Include the Owner's Manual number and equipment identification numbers.

Electronic copies of this manual can also be downloaded at no charge in Acrobat PDF format by going to the CIGWELD web site listed below and clicking on the Literature Library link:

<http://www.cigweld.com.au>

2.02 Equipment Identification

The unit's identification number (specification or part number), model, and serial number usually appear on a nameplate attached to the control panel. In some cases, the nameplate may be attached to the rear panel. Equipment which does not have a control panel such as gun and cable assemblies is identified only by the specification or part number printed on the shipping container. Record these numbers on the bottom of page i for future reference.

2.03 Receipt Of Equipment













When you receive the equipment, check it against the invoice to make sure it is complete and inspect the equipment for possible damage due to shipping. If there is any damage, notify the carrier immediately to file a claim. Furnish complete information concerning damage claims or shipping errors to the location in your area listed in the inside back cover of this manual.

















Include all equipment identification numbers as described above along with a full description of the parts in error.













Move the equipment to the installation site before un-crating the unit. Use care to avoid damaging the equipment when using bars, hammers, etc., to un-crate the unit.

2.04 Symbol Chart

Note that only some of these symbols will appear on your model.

	On
	Off
	Dangerous Voltage
	Increase/Decrease
	Circuit Breaker
	AC Auxiliary Power
	Fuse
A	Amperage
V	Voltage
Hz	Hertz (cycles/sec)
f	Frequency
-	Negative
+	Positive
	Direct Current (DC)
	Protective Earth (Ground)
	Line
	Line Connection
	Auxiliary Power
115V 15A 	Receptacle Rating- Auxiliary Power

1 	Single Phase
3 	Three Phase
	Three Phase Static Frequency Converter- Transformer-Rectifier
	Remote
X	Duty Cycle
%	Percentage
	Panel/Local
	Shielded Metal Arc Welding (SMAW)
	Gas Metal Arc Welding (GMAW)
	Gas Tungsten Arc Welding (GTAW)
	Air Carbon Arc Cutting (CAC-A)
	Constant Current
	Constant Voltage Or Constant Potential
	High Temperature
	Fault Indication
	Arc Force
	Touch Start (GTAW)
	Variable Inductance
	Voltage Input

	Wire Feed Function
	Wire Feed Towards Workpiece With Output Voltage Off.
	Welding Gun
	Purging Of Gas
	Continuous Weld Mode
	Spot Weld Mode
	Spot Time
	Prewflow Time
	Postflow Time
	2 Step Trigger Operation Press to initiate wirefeed and welding, release to stop.
	4 Step Trigger Operation Press and hold for preflow, release to start arc. Press to stop arc, and hold for preflow.
	Burnback Time
	Disturbance In Ground System
IPM	Inches Per Minute
MPM	Meters Per Minute

ART# A-04937

2.05 Description

WeldSkill 140 Inverter

This compact, portable, inverter welding machine has infinitely adjustable welding current from 10 to 140 amps. It runs standard general purpose 2.5mm electrodes for light gauge work, generally less than 3.0mm thick and 3.2mm electrodes for heavier materials. The unit also has a lift TIG function that offers stable TIG welding characteristics when used with a suitable TIG torch and shielding gas.

WeldSkill 180 Inverter

This compact heavy duty, inverter welding machine has infinitely adjustable welding current from 10 to 180 amps. It runs standard general purpose 2.5mm electrodes for light gauge work, generally less than 3.0mm thick, and 4.0mm electrodes for heavier material. The unit also has a lift TIG function that offers stable TIG welding characteristics when used with a suitable TIG torch and shielding gas.

2.06 User Responsibility

This equipment will perform as per the information contained herein when installed, operated, maintained and repaired in accordance with the instructions provided. This equipment must be checked periodically. Defective equipment (including welding leads) should not be used. Parts that are broken, missing, plainly worn, distorted or contaminated, should be replaced immediately. Should such repairs or replacements become necessary, it is recommended that such repairs be carried out by appropriately qualified persons approved by CIGWELD. Advice in this regard can be obtained by contacting accredited CIGWELD Distributor.

This equipment or any of its parts should not be altered from standard specification without prior written approval of CIGWELD. The user of this equipment shall have the sole responsibility for any malfunction which results from improper use or unauthorised modification from standard specification, faulty maintenance, damage or improper repair by anyone other than appropriately qualified persons approved by CIGWELD.

2.07 Packaged Item

WeldSkill 140 Inverter with Toolbox (Part No. W1008140)

- WeldSkill 140 Inverter Power Source
- 4m Lead with Twistlock Electrode Holder
- 4m Lead with Work Clamp
- Shoulder Strap
- Toolbox
- Operating Manual

WeldSkill 180 Inverter with Toolbox (Part No. W1008180)

- WeldSkill 180 Inverter Power Source
- 4m Lead with Twistlock Electrode Holder
- 4m Lead with Work Clamp
- Shoulder Strap
- Toolbox
- Operating Manual



Art # A-12886

2.08 Transporting Methods

These units are equipped with a handle for carrying purposes.



WARNING

ELECTRIC SHOCK can kill. DO NOT TOUCH live electrical parts. Disconnect input power conductors from de-energized supply line before moving the welding power source.



WARNING

FALLING EQUIPMENT can cause serious personal injury and equipment damage.

Lift unit with handle on top of case.

Use handcart or similar device of adequate capacity.

If using a fork lift vehicle, place and secure unit on a proper skid before transporting.

2.09 Duty Cycle

The rated duty cycle of a Welding Power Source, is a statement of the time it may be operated at its rated welding current output without exceeding the temperature limits of the insulation of the component parts. To explain the 10 minute duty cycle period the following example is used. Suppose a Welding Power Source is designed to operate at a 15% duty cycle, 90 amperes at 23.6 volts. This means that it has been designed and built to provide the rated amperage (90A) for 1.5 minutes, i.e. arc welding time, out of every 10 minute period (15% of 10 minutes is 1.5 minutes). During the other 8.5 minutes of the 10 minute period the Welding Power Source must idle and allowed to cool.

2.10 Specifications

Description	WeldSkill 140	WeldSkill 180
Toolbox Plant Part No	W1008140	W1008180
Power Source Dimensions	H200mmxW120mmxD315mm	H220mmxW130mmxD340mm
Power Source Mass	4.7 KG	5.8 KG
Cooling	Fan Cooled	Fan Cooled
Welder Type	Stick and Lift TIG Multi Process Inverter Power Source	Stick and Lift TIG Multi Process Inverter Power Source
Australian Standard	AS 60974.1-2006 / IEC 60974-1	AS 60974.1-2006 / IEC 60974-1
Number of Phases	Single Phase	Single Phase
Nominal Supply Voltage	240V AC \pm 10%	240V AC \pm 10%
Nominal Supply Frequency	50/60 Hz	50/60 Hz
Welding Current Range	10 - 140 A	10 - 180 A
Nominal DC Open Circuit Voltage	80 V	78 V
Factory Fitted Supply Plug Rating	10 Amps	15 Amps
Effective Input Current ($I_{1\text{eff}}$) refer Note 2	10 Amps	15 Amps
Maximum Input Current ($I_{1\text{max}}$)	26.3 Amps	33.8 Amps
Minimum Single Phase Generator Recommendation (refer Note 4)	6.0 kW (7.5 kVA @ 0.8 PF)	7.6 kW (9.5 kVA @ 0.8 PF)
STICK (MMAW) Welding Output, 40°C, 10 min.	140 A @ 15%, 25.6 V	180 A @ 20%, 27.2 V
	99 A @ 30%, 24V	147 A @ 30%, 25.9V
	75A @ 60%, 23.0V	110 A @ 60%, 24.4 V
	58 A @ 100%, 22.3 V	90 A @ 100%, 23.6 V
TIG (GTAW) Welding Output, 40°C, 10 min.	140 A @ 35%, 15.6 V	180 A @ 40%, 17.2 V
	110 A @ 60%, 14.4 V	150 A @ 60%, 16 V
	85 A @ 100%, 13.4 V	115 A @ 100%, 14.6 V
Protection Class	IP21S	IP21S

Table 2-1: Specifications

NOTE 1

Due to variations that can occur in manufactured products, claimed performance, voltages, ratings, all capacities, measurements, dimensions and weights quoted are approximate only. Achievable capacities and ratings in use and operation will depend upon correct installation, use, applications, maintenance and service.

NOTE 2

The Effective Input Current should be used for the determination of cable size & supply requirements.

NOTE 3

Motor start fuses or thermal circuit breakers are recommended for this application. Check local requirements for your situation in this regard.

NOTE 4

Minimum Generator Recommendation at the Maximum Output Duty Cycle.

Due to large variations in performance and specifications of different brands and types of generators, CIGWELD cannot guarantee full welding output power or duty cycle on every brand or type of generator.

Some small generators incorporate low cost circuit breakers on their outputs. These circuit breakers usually will have a small reset button, and will trip much faster than a switchboard type circuit breaker. This may result in not being able to achieve full output or duty cycle from the power source / generator combination. For this reason we recommend a generator that incorporates switchboard type circuit breakers.

CIGWELD recommends that when selecting a generator, that the particular power source / generator combination be adequately trialled to ensure the combination performs to the users expectations.

NOTE 5

CIGWELD reserves the right to change product performance and specifications without notice.

2.11 Optional Accessories

We recommend genuine CIGWELD products.

The biggest range and best quality with guaranteed performance.

Part Number	Description
W7003006	TIG Torch 17V, 3m lead with 25mm ² dinse (suits WeldSkill 140)
W7003021	TIG Torch 17V, 3m lead with 50mm ² dinse (suits WeldSkill 180)
BGSAK2	TIG Torch Accessory Kit for 17, 26 & 18 TIG Torches
210254	WeldSkill Regulator/Flowmeter
WS41625	WeldSkill Welding Leadset 4m, 16mm ² cable, 25mm ² dinse, 250A Twistlock Electrode Holder (suits WeldSkill 140)
646323	CIGWELD 200A Welding Leadset 5m, 16mm ² cable, 25mm ² dinse, Twistlock Electrode Holder (suits WeldSkill 140)
WS42550	WeldSkill Welding Leadset 4m, 25mm ² cable, 50mm ² dinse, 250A Twistlock Electrode Holder (suits WeldSkill 180)
WS53550	WeldSkill Welding Leadset 5m, 35mm ² cable, 50mm ² dinse, 400A Twistlock Electrode Holder (suits WeldSkill 180)

Table 2-2

2.11 Optional Accessories (Cont'd)**TIG Torch Consumables**

Part Number	Description
BG10N49/R	Nozzle Alumina 8mm, for 17, 26 & 18 TIG Torches (pkt of 5)
BG10N48/R	Nozzle Alumina 10mm, for 17, 26 & 18 TIG Torches (pkt of 5)
BG10N47/R	Nozzle Alumina 11mm, for 17, 26 & 18 TIG Torches (pkt of 5)
BG10N46/R	Nozzle Alumina 12.5mm, for 17, 26 & 18 TIG Torches (pkt of 5)
BG10N22/R	Collet 1.0mm, for 17, 26 & 18 TIG Torches (pkt of 5)
BG10N23/R	Collet 1.6mm, for 17, 26 & 18 TIG Torches (pkt of 5)
BG10N24/R	Collet 2.4mm, for 17, 26 & 18 TIG Torches (pkt of 5)
BG10N25/R	Collet 3.2mm, for 17, 26 & 18 TIG Torches (pkt of 5)
BG10N30/R	Collet Body 1.0mm, for 17, 26 & 18 TIG Torches (pkt of 5)
BG10N31/R	Collet Body 1.6mm, for 17, 26 & 18 TIG Torches (pkt of 5)
BG10N32/R	Collet Body 2.4mm, for 17, 26 & 18 TIG Torches (pkt of 5)
BG10N28/R	Collet Body 3.2mm, for 17, 26 & 18 TIG Torches (pkt of 5)
BG57Y02/R	Back Cap – Long for 17, 26 & 18 TIG Torches (pkt of 2)
BG57Y04/R	Back Cap – Short for 17, 26 & 18 TIG Torches (pkt of 2)

Table 2-3

TIG Electrodes

Part Number	Description
699846	Ceriated Electrode 1.6mm x 175mm AC/DC Grey (Pkt of 10)
699847	Ceriated Electrode 2.4mm x 175mm AC/DC Grey (Pkt of 10)
699848	Ceriated Electrode 3.2mm x 175mm AC/DC Grey (Pkt of 10)

Table 2-4

Related Products

Part Number	Description
646754	WeldSkill TIG Welding Gloves
646755	WeldSkill Heavy Duty Welding Gloves
454304	WeldSkill Auto Darkening Welding Helmet Fixed Shade 11 Black
454305	WeldSkill Auto Darkening Welding Helmet Variable Shade 9-13 Blue
454314	WeldSkill Auto Darkening Welding Helmet Variable Shade 9-13 Carbon Fibre
454321	WeldSkill Auto Darkening Welding Helmet Variable Shade 9-13 Racer
454322	WeldSkill Auto Darkening Welding Helmet Variable Shade 9-13 Tribal
454323	WeldSkill Auto Darkening Welding Helmet Variable Shade 9-13 White Carbon
454324	WeldSkill Auto Darkening Welding Helmet Variable Shade 9-13 Oz Flag
Note: CIGWELD Electrodes see page 4-5	

Table 2-5

This Page Intentionally Blank

SECTION 3: INSTALLATION

3.01 Environment

These units are designed for use in environments with increased hazard of electric shock.

A. Examples of environments with increased hazard of electric shock are:

1. In locations in which freedom of movement is restricted, so that the operator is forced to perform the work in a cramped (kneeling, sitting or lying) position with physical contact with conductive parts.
2. In locations which are fully or partially limited by conductive elements, and in which there is a high risk of unavoidable or accidental contact by the operator.

B. Environments with increased hazard of electric shock do not include places where electrically conductive parts in the near vicinity of the operator, which can cause increased hazard, have been insulated.

3.02 Location

Be sure to locate the welder according to the following guidelines:

- A. In areas, free from moisture and dust.
- B. Ambient temperature between 0° C to 40° C.
- C. In areas, free from oil, steam and corrosive gases.
- D. In areas, not subjected to abnormal vibration or shock.
- E. In areas, not exposed to direct sunlight or rain.
- F. Place at a distance of 300mm or more from walls or similar that could restrict natural air flow for cooling.

3.03 Ventilation

Since the inhalation of welding fumes can be harmful, ensure that the welding area is effectively ventilated.

3.04 Mains Supply Voltage Requirements

The Mains supply voltage should be within $\pm 10\%$ of the rated Mains supply voltage. If actual Mains Supply Voltage is outside this range Welding Current may not be available and may cause internal components to fail.

Refer to Specifications on page 2-5 for Supply Voltage information.

The Welding Power Source must be:

- Correctly installed, if necessary, by a qualified electrician.
- Correctly earthed (electrically) in accordance with local regulations.
- Connected to the correct size power point and fuse as per the Specifications on page 2-5.

IMPORTANT NOTE

This product has been fitted with a supply plug as indicated in Section 2.10. Note that the welding output range applicable with the fitted supply plug is detailed in Section 2.10.



WARNING

Any electrical work must be carried out by a qualified Electrical Tradesperson.

3.05 Generators

Refer to Note 4 on page 2-6 for recommendations when using with a Generator.

3.06 Electromagnetic Compatibility

**WARNING**

Extra precautions for Electromagnetic Compatibility may be required when this Welding Power Source is used in a domestic situation.

A. Installation and Use - Users Responsibility

The user is responsible for installing and using the welding equipment according to the manufacturer's instructions. If electromagnetic disturbances are detected then it shall be the responsibility of the user of the welding equipment to resolve the situation with the technical assistance of the manufacturer. In some cases this remedial action may be as simple as earthing the welding circuit, see NOTE below. In other cases it could involve constructing an electromagnetic screen enclosing the Welding Power Source and the work, complete with associated input filters. In all cases, electromagnetic disturbances shall be reduced to the point where they are no longer troublesome.

NOTE

The welding circuit may or may not be earthed for safety reasons. Changing the earthing arrangements should only be authorised by a person who is competent to assess whether the changes will increase the risk of injury, e.g. by allowing parallel welding current return paths which may damage the earth circuits of other equipment. Further guidance is given in IEC 974-13 Arc Welding Equipment - Installation and use (under preparation).

B. Assessment of Area

Before installing welding equipment, the user shall make an assessment of potential electromagnetic problems in the surrounding area. The following shall be taken into account

1. Other supply cables, control cables, signalling and telephone cables; above, below and adjacent to the welding equipment.
2. Radio and television transmitters and receivers.
3. Computer and other control equipment.
4. Safety critical equipment, e.g. guarding of industrial equipment.
5. The health of people around, e.g. the use of pacemakers and hearing aids.

6. Equipment used for calibration and measurement.
7. The time of day that welding or other activities are to be carried out.
8. The immunity of other equipment in the environment: the user shall ensure that other equipment being used in the environment is compatible: this may require additional protection measures.

The size of the surrounding area to be considered will depend on the structure of the building and other activities that are taking place. The surrounding area may extend beyond the boundaries of the premises.

C. Methods of Reducing Electromagnetic Emissions

1. Mains Supply

Welding equipment should be connected to the mains supply according to the manufacturer's recommendations. If interference occurs, it may be necessary to take additional precautions such as filtering of the mains supply. Consideration should be given to shielding the supply cable of permanently installed welding equipment in metallic conduit or equivalent. Shielding should be electrically continuous throughout its length. The shielding should be connected to the Welding Power Source so that good electrical contact is maintained between the conduit and the Welding Power Source enclosure.

2. Maintenance of Welding Equipment

The welding equipment should be routinely maintained according to the manufacturer's recommendations. All access and service doors and covers should be closed and properly fastened when the welding equipment is in operation. The welding equipment should not be modified in any way except for those changes and adjustments covered in the manufacturer's instructions. In particular, the spark gaps of arc striking and stabilising devices should be adjusted and maintained according to the manufacturer's recommendations.

3. Welding Cables

The welding cables should be kept as short as possible and should be positioned close together, running at or close to the floor level.

4. Equipotential Bonding

Bonding of all metallic components in the welding installation and adjacent to it should be considered. However, metallic components bonded to the work piece will increase the risk that the operator could receive a shock by touching the metallic components and the electrode at the same time. The operator should be insulated from all such bonded metallic components.

5. Earthing of the Workpiece

Where the workpiece is not bonded to earth for electrical safety, nor connected to earth because of its size and position, e.g. ship's hull or building steelwork, a connection bonding the workpiece to earth may reduce emissions in some, but not all instances. Care should be taken to prevent the earthing of the workpiece increasing the risk of injury to users, or damage to other electrical equipment. Where necessary, the connection of the workpiece to earth should be made by direct connection to the workpiece, but in some countries where direct connection is not permitted, the bonding should be achieved by suitable capacitance, selected according to national regulations.

6. Screening and Shielding

Selective screening and shielding of other cables and equipment in the surrounding area may alleviate problems of interference. Screening the entire welding installation may be considered for special applications.

This Page Intentionally Blank

SECTION 4: OPERATION

4.01 Overview

Conventional operating procedures apply when using the Welding Power Source, i.e. connect work lead directly to workpiece and electrode lead is used to hold electrode (Consult the electrode manufacturers information for the correct polarity). The welding current range values should be used as a guide only. Current delivered to the arc is dependent on the welding arc voltage, and as welding arc voltage varies between different classes of electrode, welding current at any one setting would vary according to the type of electrode in use. The operator should use the welding current range values as a guide, then finally adjust the current setting to suit the application.

4.02 Power Source Controls, Indicators and Features

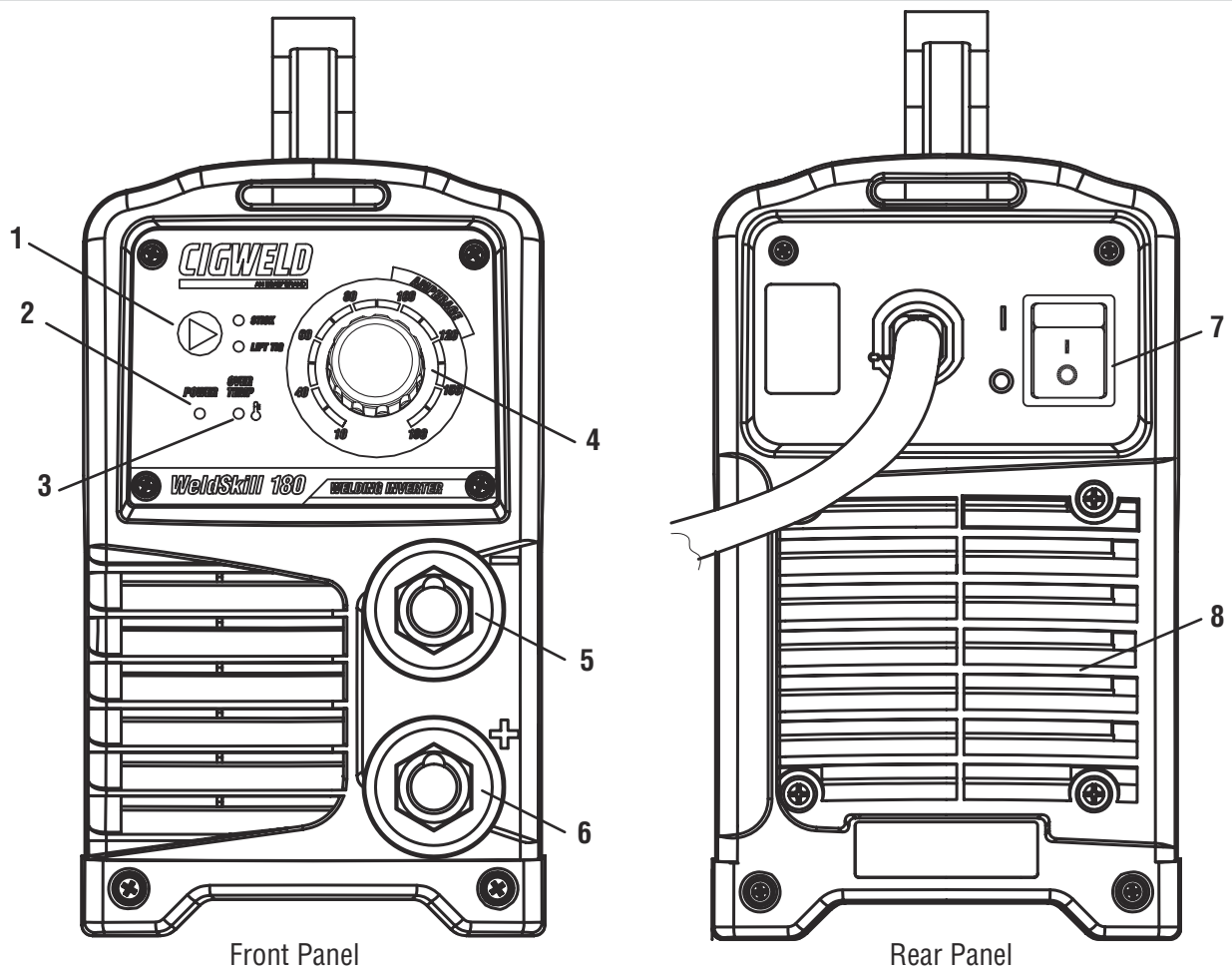

Art # A-12796

Figure 4-1

1. Process Selection Control

The process selection control is used to select the desired welding mode. Two modes are available, Stick (MMAW) and Lift TIG (GTAW) modes. Refer to section 5.01 for Stick (MMAW) set-up details or section 6.01 for Lift TIG (GTAW) set-up details.

2. Power Indicator

The power indicator is illuminated when nominal 240V AC mains power is applied to the power source and the ON/OFF switch located on the rear panel is in the ON position.

3. Over Temp Indicator

This welding power source is protected by a self resetting thermostat. The Over Temp indicator will illuminate if the machine has over heated which normally occurs if the duty cycle of the power source has been exceeded. Should the Over Temp indicator illuminate the output of the power source will be disabled. Leave the power source turned On to allow the internal components to cool down. Once the power source cools down sufficiently the Over Temp indicator will automatically go off. Note that the On/Off switch should remain in the On position such that the fan continues to operate thus allowing the power source to cool sufficiently. Do not switch the power source Off if an Over Temp condition is present.

4. Amperage Control (Welding Current)

The amperage control knob adjusts the amount of welding current delivered by the power source. The amperage is increased by turning the amperage clockwise or decreased by turning the amperage control knob anti-clockwise. The amperage should be set according to the electrode type and the specific application. Refer to application notes in this manual for further information.

5. Negative Welding Output Terminal

The negative welding terminal is used to connect the welding output of the power source to the work lead. Most General Purpose electrodes are connected with work lead to negative. Consult the electrode manufacturer's information for the correct polarity.

Welding current flows from the workpiece via this Dinse type terminal to the power source. It is essential, however, that the male dinse type plug is inserted and turned securely to achieve a sound electrical connection. Do not over tighten.

CAUTION 1

Loose welding terminal connections can cause overheating and result in the male plug being fused in the Dinse terminal.

6. Positive Welding Output Terminal

The positive welding terminal is used to connect the welding output of the power source to the electrode holder lead. Most General Purpose electrodes are connected with electrode to positive. Consult the electrode manufacturer's information for the correct polarity.

Positive welding current flows from the power source via this Dinse type terminal. It is essential, however, that the male Dinse type plug is inserted and turned securely to achieve a sound electrical connection. Do not over tighten.

CAUTION 2

Loose welding terminal connections can cause overheating and result in the male plug being fused in the Dinse terminal.

7. On/Off Switch

This switch is used to turn the unit ON/OFF. When this switch is turned ON the Power Indicator on the front panel will illuminate.

8. Fan

The Fan is turned ON/OFF by the Power Switch on the rear panel of the machine.

9. Hot Start Feature (Not Shown)

This feature operates in Stick (Manual Arc) mode. The Hot Start feature improves the arc start characteristics by momentarily increasing the welding current to a level above the preset amperage (Welding Current). This is a preset feature and is not adjustable.

10. Arc Force Feature (Not Shown)

This feature operates in Stick (Manual Arc) mode.

Stick electrodes can sometimes 'stick' to the work piece when pushed into a tight corner or joint fit-up with particular stick electrodes. The Arc force feature can be particularly beneficial in helping to overcome this by automatically increasing current when the machine senses a decrease in voltage levels. This is a preset feature and is not adjustable.

11. Anti Stick Feature (Not Shown)

This feature operates in Stick (Manual Arc) mode.

The anti stick feature senses when the electrode sticks and automatically reduces the current to prevent the Stick Electrode from sticking to the work piece. This is a preset feature and is not adjustable.

This Page Intentionally Blank

SECTION 5: STICK (MMAW) WELDING

5.01 Setup For STICK (MMAW) Welding

- Select Stick mode with the process selection control (refer to Section 4.02.1 for further information).
- Connect the Electrode Holder lead to the positive welding terminal (+). If in doubt, consult the electrode manufacturer. Welding current flows from the Power Source via Dinse type terminals. It is essential, however, that the male plug is inserted and turned securely to achieve a sound electrical connection.
- Connect the work lead to the negative welding terminal (-). If in doubt, consult the electrode manufacturer. Welding current flows from the power source via Dinse type terminals. It is essential, however, that the male plug is inserted and turned securely to achieve a sound electrical connection.



WARNING

Before connecting the work clamp to the work and inserting the electrode in the electrode holder make sure the Mains power supply is switched off.



CAUTION

Remove any packaging material prior to use. Do not block the air vents at the front or rear of the Welding Power Source.

NOTE

Consult the electrode manufacturer's information for the correct polarity.

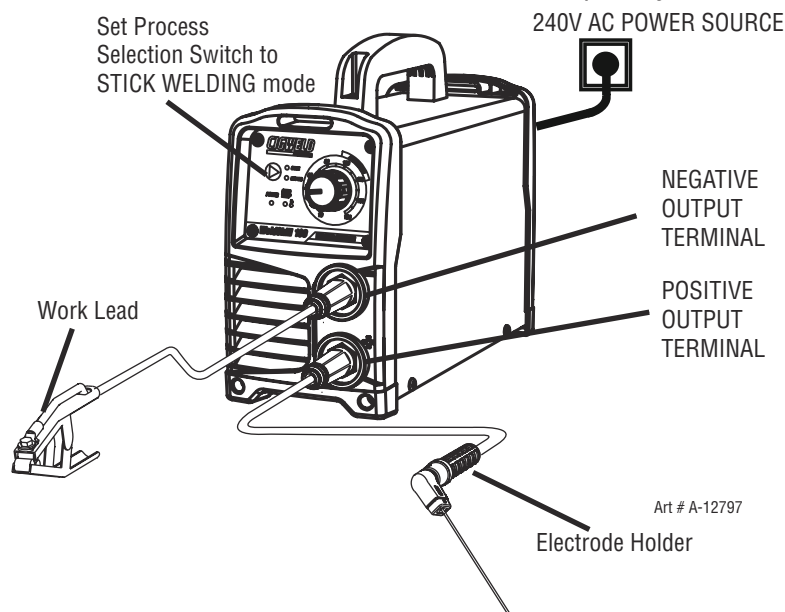

Figure 5-1: Setup For STICK (MMAW) Welding

5.02 Arc Welding Electrodes

Metal arc welding electrodes consist of a core wire surrounded by a flux coating. The flux coating is applied to the core wire by an extrusion process.

The coating on arc welding electrodes serves a number of purposes:

- A. To provide a gaseous shield for the weld metal, and preserve it from contamination by the atmosphere whilst in a molten state.
- B. To give a steady arc by having 'arc stabilisers' present, which provide a bridge for current to flow across.
- C. To remove oxygen from the weld metal with 'deoxidisers'.
- D. To provide a cleansing action on the work piece and a protective slag cover over the weld metal to prevent the formation of oxides while the metal is solidifying. The slag also helps to produce a bead of the desired contour.
- E. To introduce alloys into the weld deposits in special type electrodes.

5.03 Types of Electrodes

Arc Welding electrodes are classified into a number of groups depending on their applications. There are a great number of electrodes used for specialised industrial purposes which are not of particular interest for everyday general work. These include some low hydrogen types for high tensile steel, cellulose types for welding large diameter pipes, etc.

The range of electrodes dealt with in this publication will cover the vast majority of applications likely to be encountered; are all easy to use and all will work on even the most basic of welding machines.

CIGWELD Electrode Selection Chart

Description	Diameter	Pack	Part No.	Application
Saticraft 13	2.5mm	1kg	322135	General purpose electrode suitable for all positional welding and galvanised steel.
	2.5mm	2.5kg	612182	
	3.2mm	1kg	322136	
	3.2mm	2.5kg	612183	
	4.0mm	5kg	611184	
Ferrocraft 12XP	2.0mm	1kg	322128	General purpose, extra performance electrode recommended for all positional (inc. Vertical down) welding of mild and galvanised steel.
	2.0mm	2.5kg	612231	
	2.5mm	1kg	322129	
	2.5mm	2.5kg	612232	
	3.2mm	1kg	322138	
	3.2mm	2.5kg	612233	
	4.0mm	5kg	611234	
WeldSkill GP	2.0mm	1 kg	WEG1020	User-friendly GP electrode for welding thin section mild and galvanised steels. Excellent for vertical down fillet welding applications.
	2.0mm	2.5 kg	WEG2520	
	2.5mm	1 kg	WEG1025	
	2.5mm	2.5 kg	WEG2525	
	2.5mm	5 kg	WEG5025	
	3.2mm	1 kg	WEG1032	
	3.2mm	2.5 kg	WEG2532	
	3.2mm	5 kg	WEG5032	
	4.0mm	5 kg	WEG5040	
Ferrocraft 16 Twincoat	2.5mm	5 kg	611752	Hydrogen Controlled type offering exceptional AC/DC performance in all welding positions.
	3.2mm	5 kg	611753	
	4.0mm	5 kg	611754	
Saticrome 308L-17	2.5mm	2.5 kg	611602	Stainless Steel type for 19Cr/10Ni stainless grades including 201, 202, 301, 302, 303, 304, 304L, 305, 308, etc
	3.2mm	2.5 kg	611603	
	4.0mm	2.5 kg	611604	

Cigweld Electrode Selection Chart continued over page

CIGWELD Electrode Selection Chart cont'd				
Description	Diameter	Pack	Part No.	Application
Satinchrome 309Mo-17	2.5mm	2.5 kg	611692	Stainless Steel type for 309 and 309L grades. It is also suitable for welding of dissimilar welding of other 300 series stainless steels.
	3.2mm	2.5 kg	611693	
	4.0mm	2.5 kg	611694	
Satinchrome 316L-17	2.0mm	2,5 kg	611661	Stainless Steel type for welding of matching Mo bearing grades, 316 and 316L.
	2.5mm	2.5 kg	611662	
	3.2mm	2.5 kg	611663	
	2.5/3.2mm	Blisterpack	322215	
Weldall	4.0mm	2.5 kg	611664	High alloy stainless steel type for welding of unknown steels, repair of die or tool steels and for joining dissimilar steels. (Not recommended for cast iron).
	2.5mm	2.5 kg	611702	
	3.2mm	2.5 kg	611703	
	2.5/3.2mm	Blisterpack	322216	
Castcraft 55	4.0mm	2.5 kg	611704	For repair and maintenance welding of S.G. cast iron, meehanite and other cast irons. It produces a higher strength weld than Castcraft 100.
	3.2mm	2.5 kg	611723	
Castcraft 100	2.5mm	2.5 kg	611732	Soft, Ductile Nickel type electrode for repair and maintenance welding of a wide range of cast irons. It has better "wetting" action than Castcraft 55.
	3.2mm	2.5 kg	611733	
	Blisterpack	Blisterpack	322217	
	4.0mm	2.5 kg	611734	

Table 5-1 Types of Electrodes

5.04 Size of Electrode

The electrode size is determined by the thickness of metals being joined and can also be governed by the type of welding machine available. Small welding machines will only provide sufficient current (amperage) to run the smaller size electrodes.

For most work, a 2.5mm electrode will be quite sufficient. A 2.5mm electrode will give just as strong a joint but may require a few more weld runs to be put down to fill the joint.

For thin sections, it is necessary to use smaller electrodes otherwise the arc may burn holes through the job. A little practice will soon establish the most suitable electrode for a given application.

5.05 Storage of Electrodes

Always store electrodes in a dry place and in their original containers.

5.06 Electrode Polarity

Electrodes are connected to the Electrode Holder, and the Work Lead is connected to the work piece. Consult the Electrode manufacturer's information for the correct polarity.

5.07 Effects of Arc Welding Various Materials

A. High tensile and alloy steels

The two most prominent effects of welding these steels are the formation of a hardened zone in the weld area, and, if suitable precautions are not taken, the occurrence in this zone of under-bead cracks may result. Hardened zone and under-bead cracks in the weld area may be reduced by using the correct electrodes, preheating, using higher current settings, using larger electrode sizes, short runs for larger electrode deposits or tempering in a furnace.

B. Austenitic manganese steels

The effect on manganese steel of slow cooling from high temperatures is to embrittle it. For this reason it is absolutely essential to keep manganese steel cool during welding by quenching after each weld or skip welding to distribute the heat.

C. Cast Iron

Most types of cast iron, except white iron, are weldable. White iron, because of its extreme brittleness, generally cracks when attempts are made to weld it. Trouble may also be experienced when welding white-heart malleable, due to the porosity caused by gas held in this type of iron.

D. Copper and alloys

The most important factor is the high rate of heat conductivity of copper, making preheating of heavy sections necessary to give proper fusion of weld and base metal.

5.08 Arc Welding Practice

The techniques used for arc welding are almost identical regardless of what types of metals are being joined. Naturally enough, different types of electrodes would be used for different metals as described in the preceding section.

5.09 Welding Position

The electrodes dealt with in this publication can be used in most positions, i.e. they are suitable for welding in flat, horizontal, vertical and overhead positions. Numerous applications call for welds to be made in positions intermediate between these. Some of the common types of welds are shown in Figures 5-2 through 5-9.

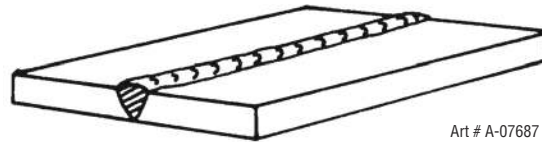

Art # A-07687

Figure 5-2: Flat position, down hand butt weld

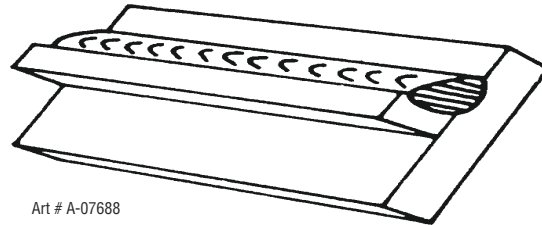

Art # A-07688

Figure 5-3: Flat position, gravity fillet weld

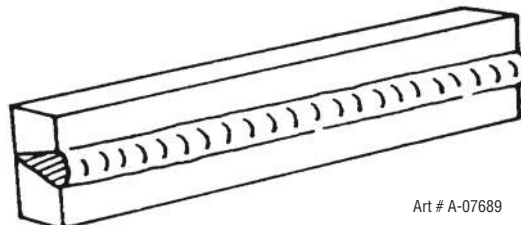

Art # A-07689

Figure 5-4: Horizontal position, butt weld

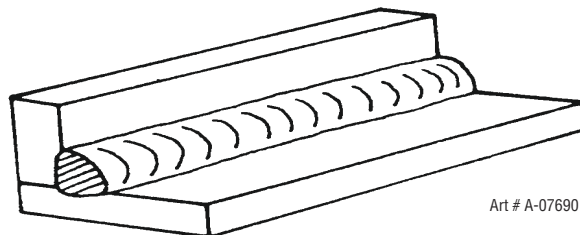

Art # A-07690

Figure 5-5: Horizontal - Vertical (HV) position

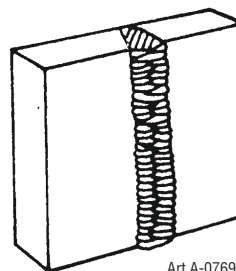

Art A-07691

Figure 5-6: Vertical position, butt weld

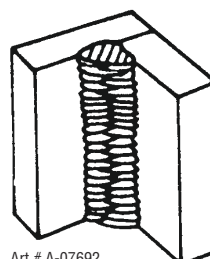

Art # A-07692

Figure 5-7: Vertical position, fillet weld

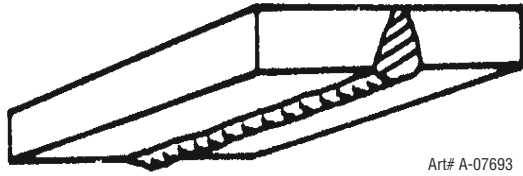

Figure 5-8: Overhead position, butt weld

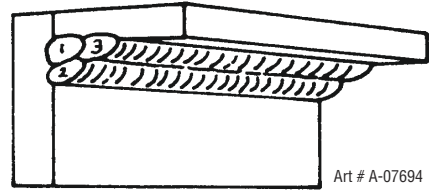

Figure 5-9: Overhead position fillet, weld

5.10 Joint Preparations

In many cases, it will be possible to weld steel sections without any special preparation. For heavier sections and for repair work on castings, etc., it will be necessary to cut or grind an angle between the pieces being joined to ensure proper penetration of the weld metal and to produce sound joints.

In general, surfaces being welded should be clean and free of rust, scale, dirt, grease, etc. Slag should be removed from oxy-cut surfaces. Typical joint designs are shown in Figure 5-10.

Open Square Butt Joint

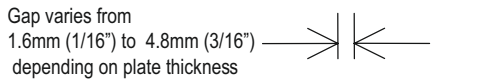

Single Vee Butt Joint

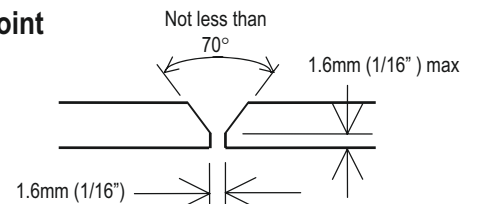

Single Vee Butt Joint

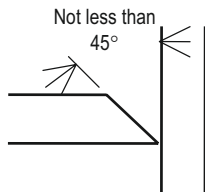

Double Vee Butt Joint

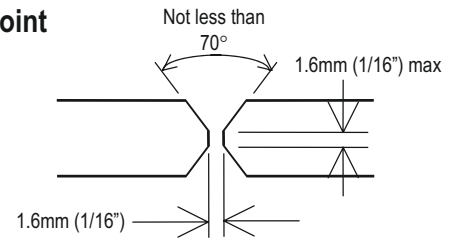

Lap Joint

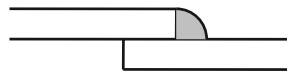

Fillet Joint

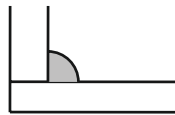

Tee Joints (Fillet both sides of the joint)

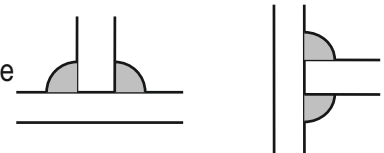

Corner Weld

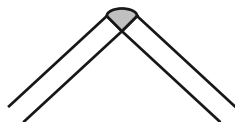

Edge Joint

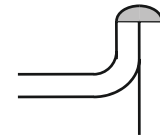

Plug Weld

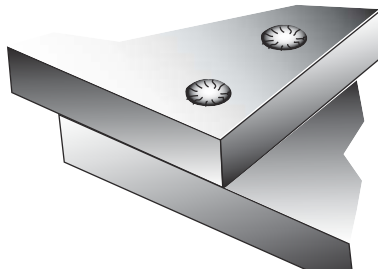

Plug Weld

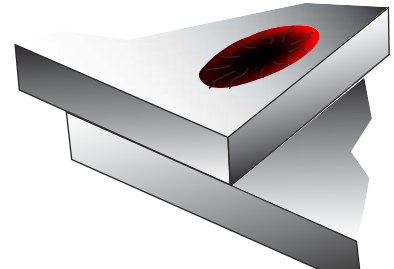

Figure 5-10: Typical joint designs for arc welding

5.11 Arc Welding Technique

A Word to Beginners

For those who have not yet done any welding, the simplest way to commence is to run beads on a piece of scrap plate. Use mild steel plate about 6.0mm thick and a 3.2mm electrode. Clean any paint, loose scale or grease off the plate and set it firmly on the work bench so that welding can be carried out in the downhand position. Make sure that the work clamp is making good electrical contact with the work, either directly or through the work table. For light gauge material, always clamp the work lead directly to the job, otherwise a poor circuit will probably result.

5.12 The Welder

Place yourself in a comfortable position before beginning to weld. Get a seat of suitable height and do as much work as possible sitting down. Don't hold your body tense. A taut attitude of mind and a tensed body will soon make you feel tired. Relax and you will find that the job becomes much easier. You can add much to your peace of mind by wearing a leather apron and gauntlets. You won't be worrying then about being burnt or sparks setting alight to your clothes.

Place the work so that the direction of welding is across, rather than to or from, your body. The electrode holder lead should be clear of any obstruction so that you can move your arm freely along as the electrode burns down. If the lead is slung over your shoulder, it allows greater freedom of movement and takes a lot of weight off your hand. Be sure the insulation on your cable and electrode holder is not faulty, otherwise you are risking an electric shock.

5.13 Striking the Arc

Practice this on a piece of scrap plate before going on to more exacting work. You may at first experience difficulty due to the tip of the electrode "sticking" to the work piece. This is caused by making too heavy a contact with the work and failing to withdraw the electrode quickly enough. A low amperage will accentuate it. This freezing-on of the tip may be overcome by scratching the electrode along the plate surface in the same way as a match is struck. As soon as the arc is established, maintain a 1.6mm to 3.2mm gap between the burning electrode end and the parent metal. Draw the electrode slowly along as it melts down.

Another difficulty you may meet is the tendency, after the arc is struck, to withdraw the electrode so far that the arc is broken again. A little practice will soon remedy both of these faults.

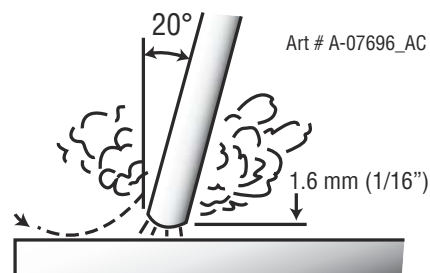

Figure 5-11: Striking an arc

5.14 Arc Length

The securing of an arc length necessary to produce a neat weld soon becomes almost automatic. You will find that a long arc produces more heat. A very long arc produces a crackling or spluttering noise and the weld metal comes across in large, irregular blobs. The weld bead is flattened and spatter increases. A short arc is essential if a high quality weld is to be obtained although if it is too short there is the danger of it being blanketed by slag and the electrode tip being solidified in. If this should happen, give the electrode a quick twist back over the weld to detach it. Contact or "touch-weld" electrodes such as Ferrocrafter 21 do not stick in this way, and make welding much easier.

5.15 Rate of Travel

After the arc is struck, your next concern is to maintain it, and this requires moving the electrode tip towards the molten pool at the same rate as it is melting away. At the same time, the electrode has to move along the plate to form a bead. The electrode is directed at the weld pool at about 20° from the vertical. The rate of travel has to be adjusted so that a well-formed bead is produced.

If the travel is too fast, the bead will be narrow and strung out and may even be broken up into individual globules. If the travel is too slow, the weld metal piles up and the bead will be too large.

5.16 Making Welded Joints

Having attained some skill in the handling of an electrode, you will be ready to go on to make up welded joints.

NOTE

The welding current range values should be used as a guide only. Current delivered to the arc is dependent on the welding arc voltage, and as welding arc voltage varies between different classes of electrode, welding current at any one setting would vary according to the type of electrode in use. The operator should use the welding current range values as a guide, then finally adjust the current setting to suit the application.

A. Butt Welds

Set up two plates with their edges parallel, as shown in Figure 5-12, allowing 1.6mm to 2.4mm gap between them and tack weld at both ends. This is to prevent contraction stresses from the cooling weld metal pulling the plates out of alignment. Plates thicker than 6.0mm should have their mating edges bevelled to form a 70° to 90° included angle. This allows full penetration of the weld metal to the root. Using a 3.2mm Ferrocrafter 21 electrode at 100 amps, deposit a run of weld metal on the bottom of the joint.

Do not weave the electrode, but maintain a steady rate of travel along the joint sufficient to produce a well-formed bead. At first you may notice a tendency for undercut to form, but keeping the arc length short, the angle of the electrode at about 20° from vertical, and the rate of travel not too fast, will help eliminate this. The electrode needs to be moved along fast enough to prevent the slag pool from getting ahead of the arc. To complete the joint in thin plate, turn the job over, clean the slag out of the back and deposit a similar weld.

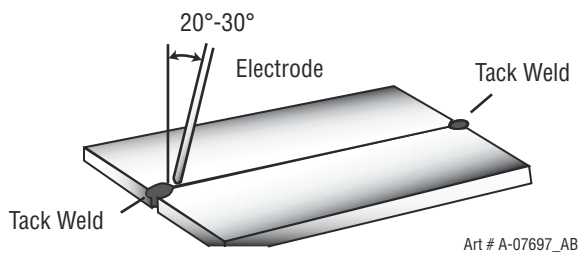

Figure 5-12: Butt weld

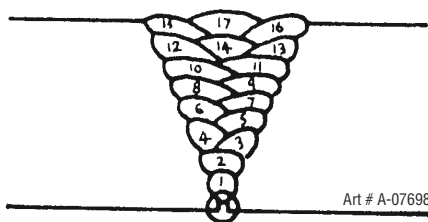

Figure 5-13: Weld build up sequence

Heavy plate will require several runs to complete the joint. After completing the first run, chip the slag out and clean the weld with a wire brush. It is important to do this to prevent slag being trapped by the second run. Subsequent runs are then deposited using either a weave technique or single beads laid down in the sequence shown in Figure 5-13. The width of weave should not be more than three times the core wire diameter of the electrode. When the joint is completely filled, the back is either machined, ground or gouged out to remove slag which may be trapped in the root, and to prepare a suitable joint for depositing the backing run. If a backing bar is used, it is not usually necessary to remove this, since it serves a similar

purpose to the backing run in securing proper fusion at the root of the weld.

B. Fillet Welds

These are welds of approximately triangular cross-section made by depositing metal in the corner of two faces meeting at right angles. Refer to Figure 5-3.

A piece of angle iron is a suitable specimen with which to begin, or two lengths of strip steel may be tacked together at right angles. Using a 3.2mm Ferrocrafter 21 electrode at 100 amps, position angle iron with one leg horizontal and the other vertical. This is known as a horizontal-vertical (HV) fillet. Strike the arc and immediately bring the electrode to a position perpendicular to the line of the fillet and about 45° from the vertical. Some electrodes require to be sloped about 20° away from the perpendicular position to prevent slag from running ahead of the weld. Refer to Figure 5-14. Do not attempt to build up much larger than 6.4mm width with a 3.2mm electrode, otherwise the weld metal tends to sag towards the base, and undercut forms on the vertical leg. Multi-runs can be made as shown in Figure 5-15. Weaving in HV fillet welds is undesirable.

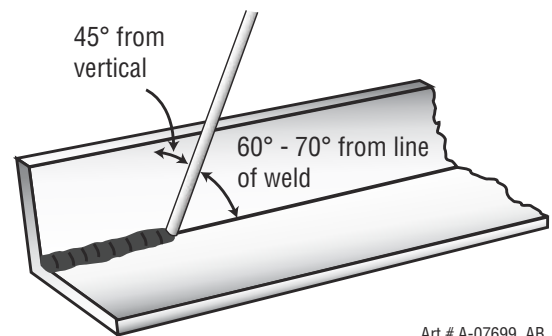

Figure 5-14: Electrode position for HV fillet weld

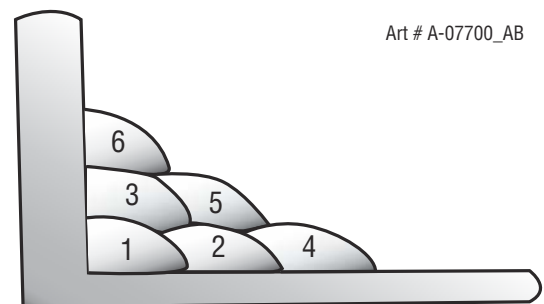

Figure 5-15: Multi-runs in HV fillet weld

C. Vertical Welds

1. Vertical Up

Tack weld a three feet length of angle iron to your work bench in an upright position. Use a 3.2mm Ferrocrafft 21 electrode and set the current at 100 amps. Make yourself comfortable on a seat in front of the job and strike the arc in the corner of the fillet. The electrode needs to be about 10° from the horizontal to enable a good bead to be deposited. Refer Figure 5-16. Use a short arc, and do not attempt to weave on the first run. When the first run has been completed de-slag the weld deposit and begin the second run at the bottom. This time a slight weaving motion is necessary to cover the first run and obtain good fusion at the edges. At the completion of each side motion, pause for a moment to allow weld metal to build up at the edges, otherwise undercut will form and too much metal will accumulate in the centre of the weld. Figure 5-17 illustrates multi-run technique and Figure 5-18 shows the effects of pausing at the edge of weave and of weaving too rapidly.

Art # A-07701

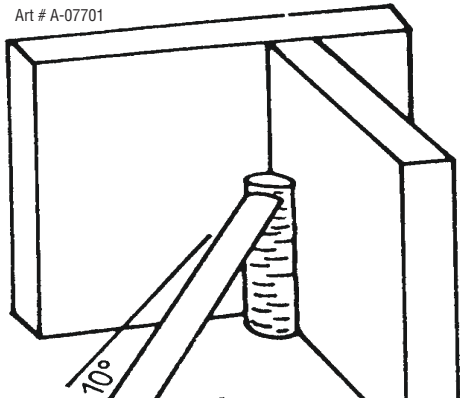

Figure 5-16: Single run vertical fillet weld

Art # A-07702

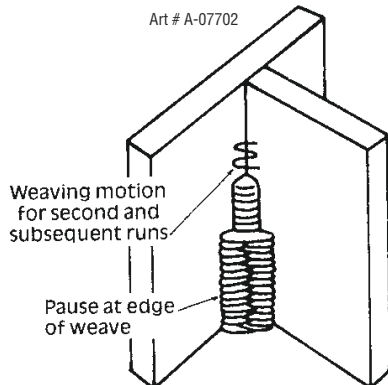
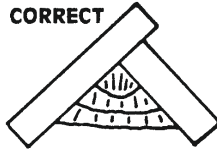

Figure 5-17: Multi run vertical fillet weld

CORRECT



Pause at edge of weave allows weld metal to build up, and eliminates undercut

INCORRECT

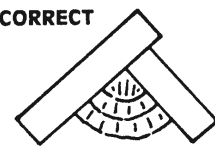

Note weld contour when insufficient pause at edge of weave

Art # A-07703

Figure 5-18: Examples of vertical fillet welds

2. Vertical Down

The Ferrocrafft 21 electrode makes welding in this position particularly easy. Use a 3.2mm electrode at 100 amps. The tip of the electrode is held in light contact with the work and the speed of downward travel is regulated so that the tip of the electrode just keeps ahead of the slag. The electrode should point upwards at an angle of about 45°.

3. Overhead Welds

Apart from the rather awkward position necessary, overhead welding is not much more difficult than downhand welding. Set up a specimen for overhead welding by first tacking a length of angle iron at right angles to another piece of angle iron or a length of waste pipe. Then tack this to the work bench or hold in a vice so that the specimen is positioned in the overhead position as shown in the sketch. The electrode is held at 45° to the horizontal and tilted 10° in the line of travel (Figure 5-19). The tip of the electrode may be touched lightly on the metal, which helps to give a steady run. A weave technique is not advisable for overhead fillet welds. Use a 3.2mm Ferrocrafft 12XP electrode at 100 amps, and deposit the first run by simply drawing the electrode along at a steady rate. You will notice that the weld deposit is rather convex, due to the effect of gravity before the metal freezes.

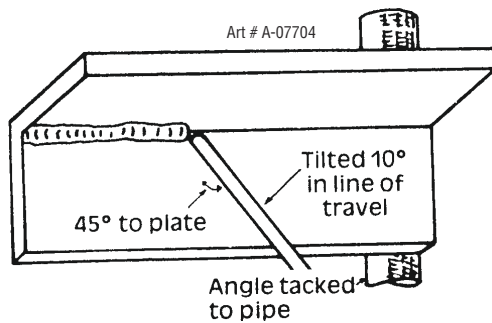

Figure 5-19: Overhead fillet weld

5.17 Distortion

Distortion in some degree is present in all forms of welding. In many cases it is so small that it is barely perceptible, but in other cases allowance has to be made before welding commences for the distortion that will subsequently occur. The study of distortion is so complex that only a brief outline can be attempted here.

5.18 The Cause of Distortion

Distortion is caused by:

A. Contraction of Weld Metal:

Molten steel shrinks approximately 11 per cent in volume on cooling to room temperature. This means that a cube of molten metal would contract approximately 2.2 per cent in each of its three dimensions. In a welded joint, the metal becomes attached to the side of the joint and cannot contract freely. Therefore, cooling causes the weld metal to flow plastically, that is, the weld itself has to stretch if it is to overcome the effect of shrinking volume and still be attached to the edge of the joint. If the restraint is very great, as, for example, in a heavy section of plate, the weld metal may crack. Even in cases where the weld metal does not crack, there will still remain stresses "locked-up" in the structure. If the joint material is relatively weak, for example, a butt joint in 2.0mm sheet, the contracting weld metal may cause the sheet to become distorted.

B. Expansion and Contraction of Parent Metal in the Fusion Zone:

While welding is proceeding, a relatively small volume of the adjacent plate material is heated to a very high temperature and attempts to expand in all directions. It is able to do this freely at right angles to the surface of the plate (i.e., "through the weld"), but when it attempts to expand "across the weld" or "along the weld", it meets considerable resistance, and to fulfil the desire for continued expansion, it has to deform plastically, that is, the metal adjacent to the weld is at a high temperature and hence rather soft, and, by expanding, pushes against the cooler, harder metal further away, and tends to bulge (or is "upset"). When the weld area begins to cool, the "upset" metal attempts to contract as much as it expanded, but, because it has been "upset", it does not resume its former shape, and the contraction of the new shape exerts a strong pull on adjacent metal. Several things can then happen.

The metal in the weld area is stretched (plastic deformation), the job may be pulled out of shape by the powerful contraction stresses (distortion), or the weld may crack, in any case, there will remain "locked-up" stresses in the job. Figures 5-20 and 5-21 illustrate how distortion is created.

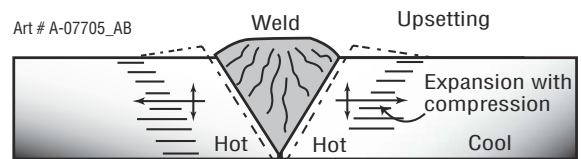

Figure 5-20: Parent metal expansion

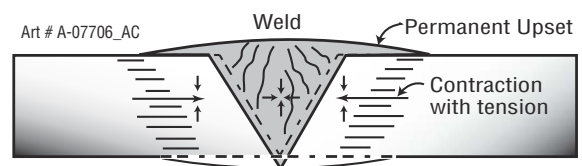

Figure 5-21: Parent metal contraction

5.19 Overcoming Distortion Effects

There are several methods of minimising distortion effects.

A. Peening

This is done by hammering the weld while it is still hot. The weld metal is flattened slightly and because of this the tensile stresses are reduced a little. The effect of peening is relatively shallow, and is not advisable on the last layer.

B. Distribution of Stresses

Distortion may be reduced by selecting a welding sequence which will distribute the stresses suitably so that they tend to cancel each other out. See Figures 5-25 through 5-28 for various weld sequences. Choice of a suitable weld sequence is probably the most effective method of overcoming distortion, although an unsuitable sequence may exaggerate it. Simultaneous welding of both sides of a joint by two welders is often successful in eliminating distortion.

C. Restraint of Parts

Forcible restraint of the components being welded is often used to prevent distortion. Jigs, positions, and tack welds are methods employed with this in view.

D. Presetting

It is possible in some cases to tell from past experience or to find by trial and error (or less frequently, to calculate) how much distortion will take place in a given welded structure. By correct pre-setting of the components to be welded, constructional stresses can be made to pull the parts into correct alignment. A simple example is shown in Figure 5-22.

E. Preheating

Suitable preheating of parts of the structure other than the area to be welded can be sometimes used to reduce distortion. Figure 5-23 shows a simple application. By removing the heating source from b and c as soon as welding is completed, the sections b and c will contract at a similar rate, thus reducing distortion.

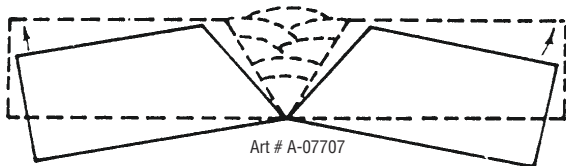
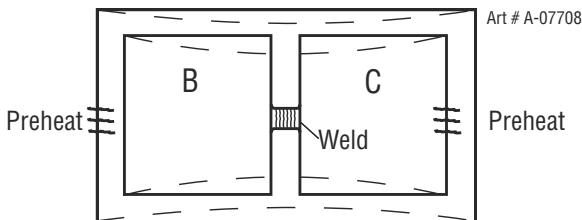

Figure 5-22: Principle of presetting



Dotted lines show effect if no preheat is used

Figure 5-23: Reduction of distortion by preheating

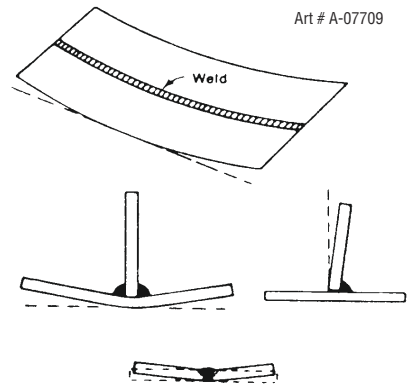

Figure 5-24: Examples of distortion

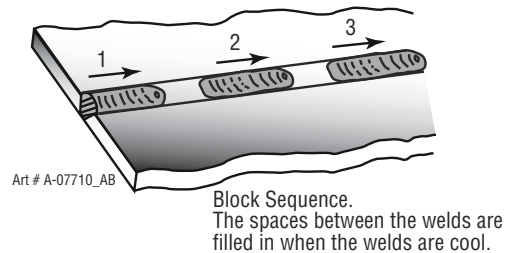

Figure 5-25: Welding sequence

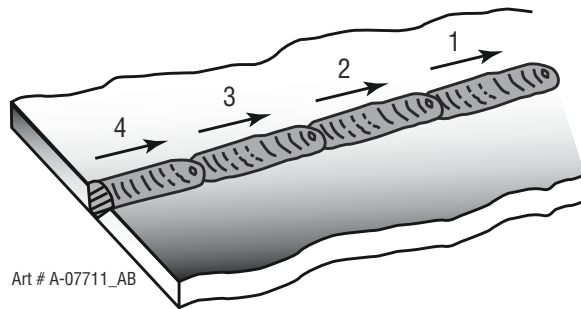

Figure 5-26: Step back sequence

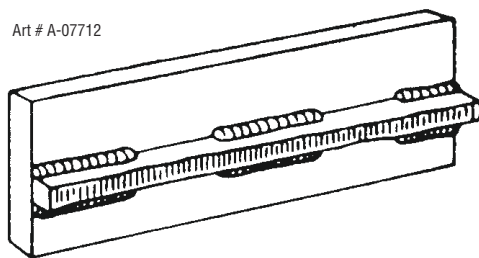

Figure 5-27: Chain intermittent welding

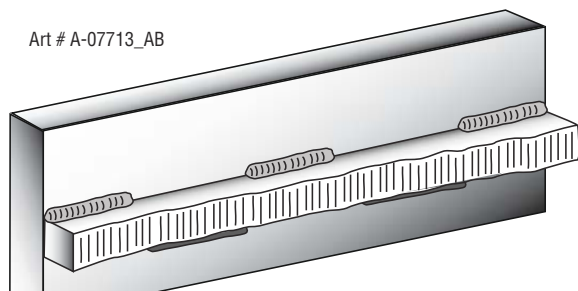

Figure 5-28: Staggered intermittent welding

5.20 Welding Problems

Description	Possible Cause	Remedy
1 Gas pockets or voids in weld metal (Porosity)	A Electrodes are damp B Welding current is too high C Surface impurities such as oil, grease, paint, etc	A Dry electrodes before use B Reduce welding current C Clean joint before welding
2 Crack occurring in weld metal soon after solidification commences	A Rigidity of joint B Insufficient throat thickness C Cooling rate is too high	A Redesign to relieve weld joint of severe stresses or use crack resistance electrodes B Travel slightly slower to allow greater build-up in throat C Preheat plate and cool slowly
3 A gap is left by failure of the weld metal to fill the root of the weld	A Welding current is too low B Electrode too large for joint C Insufficient gap D Incorrect sequence	A Increase welding current B Use smaller diameter electrode C Allow wider gap D Use correct build-up sequence

Art # A-05866_AC

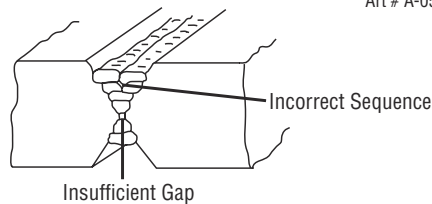

Figure 5-29: Example of Insufficient Gap or Incorrect Sequence

Description	Possible Cause	Remedy
4 Portions of the weld run do not fuse to the surface of the metal or edge of the joint	A Small electrodes used on heavy cold plate B Welding current is too low C Wrong electrode angle D Travel speed of electrode is too high E Scale or dirt on joint surface	A Use larger electrodes and preheat the plate B Increase welding current C Adjust angle so the welding arc is directed more into the base metal D Reduce travel speed of electrode E Clean surface before welding

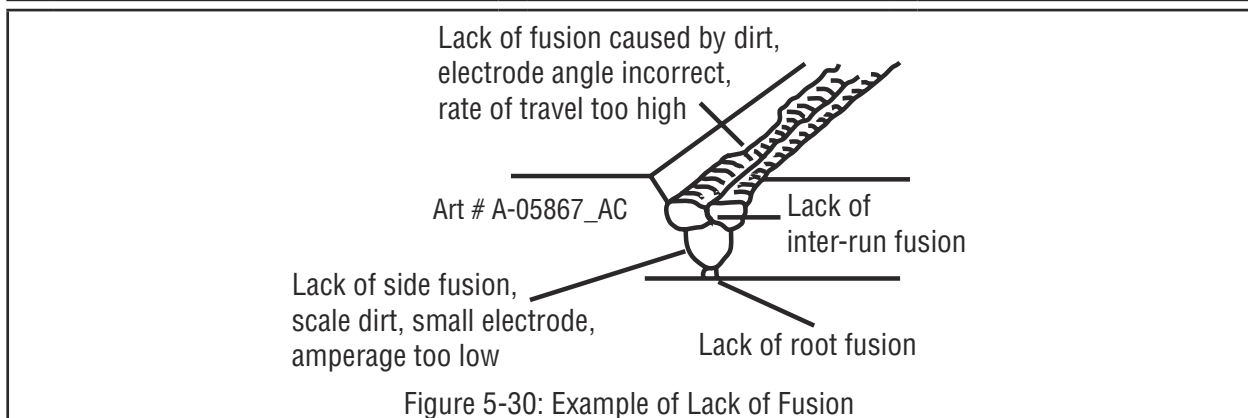
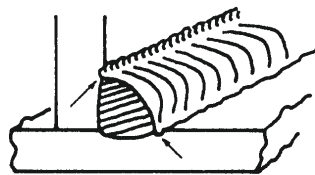

Figure 5-30: Example of Lack of Fusion

Description	Possible Cause	Remedy
5 A groove has been formed in the base metal adjacent to the toe of a weld and has not been filled by the weld metal (undercut).	<p>A Welding current is too high.</p> <p>B Welding arc is too long.</p> <p>C Angle of the electrode is incorrect.</p> <p>D Joint preparation does not allow correct electrode angle.</p> <p>E Electrode too large for joint.</p> <p>F Insufficient deposit time at edge of weave.</p>	<p>A Reduce welding current</p> <p>B Reduce the length of the welding arc</p> <p>C Electrode should not be inclined less than 45° to the vertical face</p> <p>D Allow more room in joint for manipulation of the electrode.</p> <p>E Use smaller gauge electrode.</p> <p>F Pause for a moment at edge of weave to allow weld metal build-up.</p>



Art # A-07714

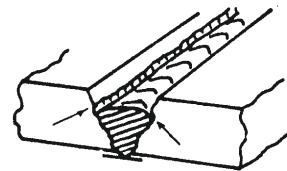
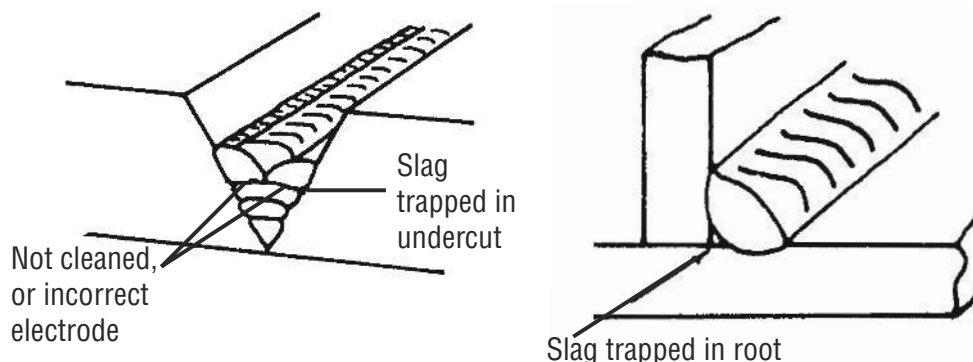

Figure 5-31: Examples of undercut

Description	Possible Cause	Remedy
<p>6 Non-metallic particles are trapped in the weld metal (slag inclusion)</p>	<p>A Non-metallic particles may be trapped in undercut from previous run</p> <p>B Joint preparation too restricted</p> <p>C Irregular deposits allow slag to be trapped</p> <p>D Lack of penetration with slag trapped beneath weld bead</p> <p>E Rust or mill scale is preventing full fusion</p> <p>F Wrong electrode for position in which welding is done</p>	<p>A If bad undercut is present, clean slag out and cover with a run from a smaller diameter electrode</p> <p>B Allow for adequate penetration and room for cleaning out the slag</p> <p>C If very bad, chip or grind out irregularities</p> <p>D Use smaller electrode with sufficient current to give adequate penetration. Use suitable tools to remove all slag from corners</p> <p>E Clean joint before welding</p> <p>F Use electrodes designed for position in which welding is done, otherwise proper control of slag is difficult</p>



Art # A-05868_AC

Figure 5-32: Examples of Slag Inclusion

Table 5-2: Welding Problems

SECTION 6: TIG (GTAW) WELDING

6.01 Shielding Gas Regulator/Flowmeter Operating Instructions



WARNING

This equipment is designed for use with welding grade (Inert) shielding gases only.

Shielding Gas Regulator/Flowmeter Safety

This regulator/flowmeter is designed to reduce and control high pressure gas from a cylinder or pipeline to the working pressure required for the equipment using it.

If the equipment is improperly used, hazardous conditions are created that may cause accidents. It is the users responsibility to prevent such conditions. Before handling or using the equipment, understand and comply at all times with the safe practices prescribed in this instruction.

SPECIFIC PROCEDURES for the use of regulators/flowmeters are listed below.

1. NEVER subject the regulator/flowmeter to inlet pressure greater than its rated inlet pressure.
2. NEVER pressurize a regulator/flowmeter that has loose or damaged parts or is in a questionable condition. NEVER loosen a connection or attempt to remove any part of a regulator/flowmeter until the gas pressure has been relieved. Under pressure, gas can dangerously propel a loose part.
3. DO NOT remove the regulator/flowmeter from a cylinder without first closing the cylinder valve and releasing gas in the regulator/flowmeter high and low pressure chambers.
4. DO NOT use the regulator/flowmeter as a control valve. When downstream equipment is not in use for extended periods of time, shut off the gas at the cylinder valve and release the gas from the equipment.
5. OPEN the cylinder valve SLOWLY. Close after use.

User Responsibilities

This equipment will perform safely and reliable only when installed, operated and maintained, and repaired in accordance with the instructions provided. Equipment must be checked periodically and repaired, replaced, or reset as necessary for continued safe and reliable performance. Defective equipment should not be used. Parts that are broken, missing, obviously worn, distorted, or contaminated should be replaced immediately.

The user of this equipment will generally have the sole responsibility for any malfunction, which results from improper use, faulty maintenance, or by repair by anyone other than an accredited repairer.



CAUTION

Match regulator/flowmeter to cylinder. NEVER CONNECT a regulator/flowmeter designed for a particular gas or gases to a cylinder containing any other gas.

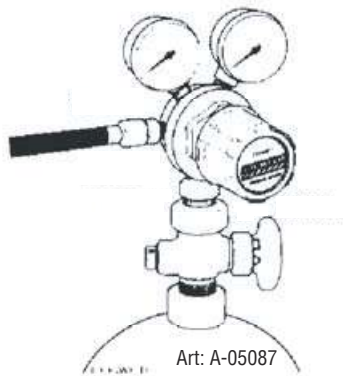

Figure 6-1: Fit Regulator/flowmeter to Cylinder

Installation

1. Remove cylinder valve plastic dust seal. Clean the cylinder valve outlet of impurities that may clog orifices and damage seats before connecting the regulator/flowmeter.

Crack the valve (open then close) momentarily, pointing the outlet away from people and sources of ignition. Wipe with a clean lint free cloth.

2. Match regulator/flowmeter to cylinder. Before connecting, check that the regulator/flowmeter label and cylinder marking agree and that the regulator/flowmeter inlet and cylinder outlet match. NEVER CONNECT a regulator/flowmeter designed for a particular gas or gases to a cylinder containing any other gas.
3. Connect the regulator/flowmeter inlet connection to cylinder or pipeline and tighten it firmly but not excessively, with a suitable spanner.
4. Connect and tighten the outlet hose firmly and attach down-stream equipment.
5. To protect sensitive down-stream equipment a separate safety device may be necessary if the regulator/flowmeter is not fitted with a pressure relief device.

Operation

With the regulator/flowmeter connected to cylinder or pipeline, and the adjustment screw/knob fully disengaged, pressurize as follows:

1. Stand to one side of regulator/flowmeter and slowly open the cylinder valve. If opened quickly, a sudden pressure surge may damage internal regulator/flowmeter parts.
2. With valves on downstream equipment closed, adjust regulator/flowmeter to approximate working pressure. It is recommended that testing for leaks at the regulator/flowmeter connection points be carried out using a suitable leak detection solution or soapy water.
3. Purge air or other unwanted welding grade shielding gas from equipment connected to the regulator/flowmeter by individually opening then closing the equipment control valves. Complete purging may take up to ten seconds or more, depending upon the length and size of the hose being purged.

Adjusting Flow Rate

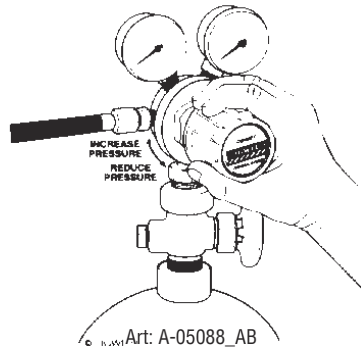

Figure 6-2: Adjust Flow Rate

With the regulator/flowmeter ready for operation, adjust working flow rate as follows:

1. Slowly turn adjusting screw/knob in (clockwise) direction until the outlet gauge indicates the required flow rate.

NOTE

It may be necessary to re-check the shielding gas regulator/flowmeter flow rate following the first weld sequence due to back pressure present within shielding gas hose assembly.

2. To reduce flow rate, allow the welding grade shielding gas to discharge from regulator/flowmeter by opening the downstream valve. Bleed welding grade shielding gas into a well ventilated area and away from any ignition source. Turn adjusting screw counterclockwise, until the required flow rate is indicated on the gauge. Close downstream valve.

Shutdown

Close cylinder valve whenever the regulator/flowmeter is not in use. To shut down for extended periods (more than 30 minutes).

1. Close cylinder or upstream valve tightly.
2. Open downstream equipment valves to drain the lines. Bleed gas into a well ventilated area and away from any ignition source.
3. After gas is drained completely, disengage adjusting screw and close downstream equipment valves.
4. Before transporting cylinders that are not secured on a cart designed for such purposes, remove regulators/flowmeters.

6.02 Setup For Lift TIG (GTAW) Welding

- A. Select Lift TIG mode with the process selection control (refer to Section 4.02.1 for further information).
- B. Connect the TIG Torch to the negative welding terminal (-). Refer to Note below for Optional TIG Torch information. Welding current flows from the power source via Dinse type terminals. It is essential, however, that the male plug is inserted and turned securely to achieve a sound electrical connection.
- C. Connect the work lead to the positive welding terminal (+). Welding current flows from the Power Source via Dinse type terminals. It is essential, however, that the male plug is inserted and turned securely to achieve a sound electrical connection.
- D. Connect an Argon Regulator/Flowmeter (not supplied) to the Argon Shielding Gas Cylinder then connect the TIG Torch gas hose to regulator. Before turning on shielding gas check that all fittings are tight and the gas valve on the TIG torch is turned off. Before commencing to TIG weld open TIG torch gas valve to allow sufficient shielding gas flow when welding. Refer to Section 6.03 for recommended Shielding Gas flow rates and other TIG Welding information.

**WARNING**

Secure the welding grade shielding gas cylinder in an upright position by chaining it to a suitable stationary support to prevent falling or tipping.

Open Gas Cylinder Valve carefully.

**WARNING**

Before connecting the work clamp to the work and inserting the electrode in the TIG torch make sure the Mains power supply is switched off.

**CAUTION**

Remove any packaging material prior to use. Do not block the air vents at the front or rear of the Welding Power Source.

NOTE

The TIG Torch is NOT supplied. It is an optional accessory. Refer to Table 2-2 on Page 2-6 for optional accessory information.

See over page for Setup for Lift TIG (GTAW) Welding diagram.

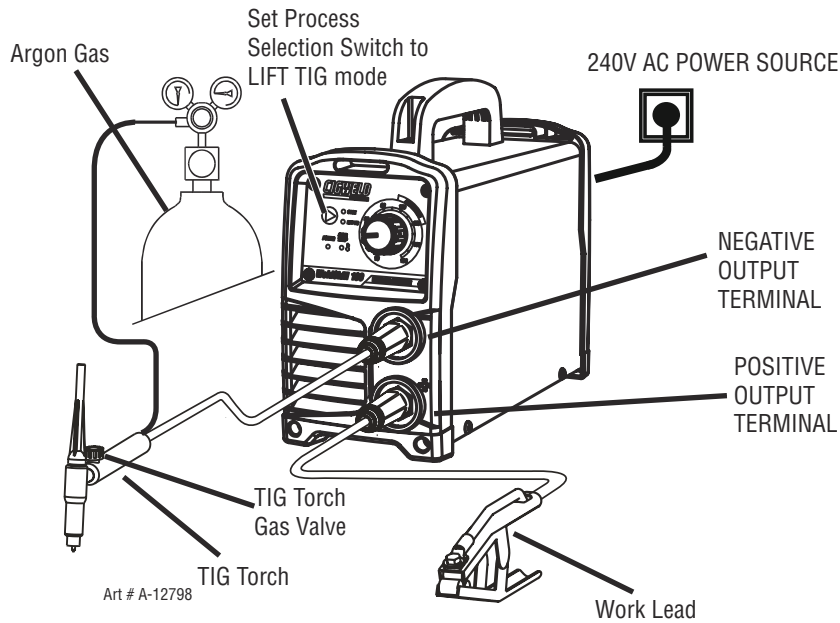

Figure 6-3: Setup For Lift TIG (GTAW) Welding

6.03 TIG (GTAW) Basic Welding Technique

Gas Tungsten Arc Welding (GTAW) or TIG (Tungsten Inert Gas) as it is commonly referred to, is a welding process in which fusion is produced by an electric arc that is established between a single tungsten (non-consumable) electrode and the work piece. Shielding is obtained from a welding grade shielding gas or welding grade shielding gas mixture which is generally Argon based. A filler metal may also be added manually in some circumstances depending on the welding application.

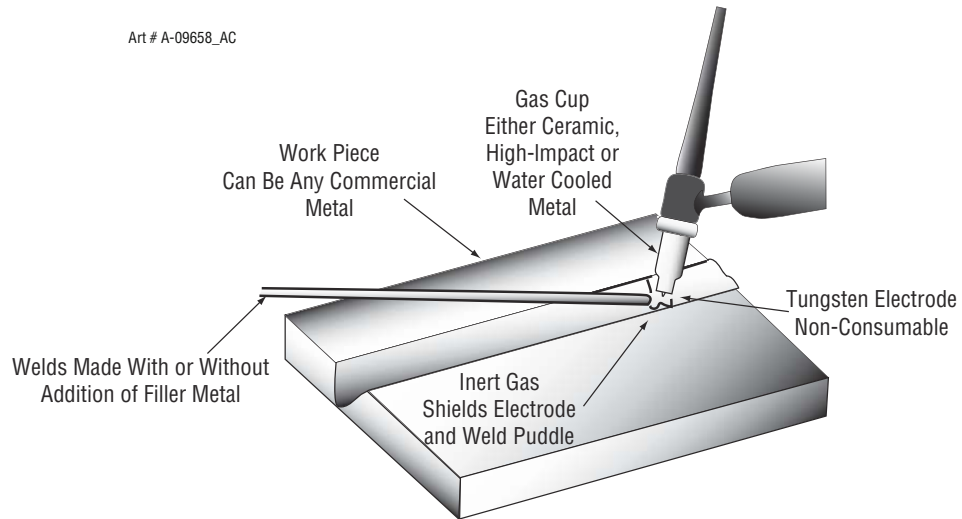

Figure 6-4: TIG Welding Application Shot

Tungsten Electrode Current Ranges

Electrode Diameter	DC Current (Amps)
0.040" (1.0mm)	30-60
1/16" (1.6mm)	60-115
3/32" (2.4mm)	100-165
1/8" (3.2mm)	135-200
5/32" (4.0mm)	190-280
3/16" (4.8mm)	250-340

Table 6-1: Current Ranges for Various Tungsten Electrode Sizes

Guide for Selecting Filler Wire Diameter

Filler Wire Diameter	DC Current Range (Amps)
1/16" (1.6mm)	20-90
3/32" (2.4mm)	65-115
1/8" (3.2mm)	100-165
3/16" (4.8mm)	200-350

Table 6-2: Filler Wire Selection Guide

NOTE

The operator should use the welding current range values as a guide only, then finally adjust the current setting to suit the application.

Tungsten Electrode Types

Electrode Type (Ground Finish)	Welding Application	Features	Colour Code
Ceriated 2%	AC & DC welding of mild steel, stainless steel, copper, aluminium, magnesium and their alloys	Longer life, More stable arc, Easier starting, Wider current range, Narrower more concentrated arc.	Grey

Table 6-3

TIG Welding Filler Rods

Comweld Rod	Aust Std	AWS Std	Part No. 1.6mm	Part No. 2.4mm	Part No. 3.2mm	Type/Application
LW1	R4	ER70S-4	321411	—	—	For mild-medium strength steels. Pipes, tubing, roll cages, etc.
LW1-6	R6	ER70S-6	321417	—	—	
Supersteel	R2	ER70S-2	321370	—	—	
CrMo1	RB2	ER80S-B2	—	321379	—	For welding of high strength Cr-Mo steels used at elevated temperatures.
CrMo2	RB3	ER90S-B3	—	321383	—	
308L	R308L	ER308L	321406	321407	—	For stainless steels. Stainless pipes, tubing, architectural uses, etc.
309L	R309L	ER309L	321403	321404	—	
316L	R316L	ER316L	321400	321401	—	

Table 6-4

Base Metal Thickness	DC Current for Mild Steel	DC Current for Stainless Steel	Tungsten Electrode Diameter	Filler Rod Diameter (if required)	Argon Gas Flow Rate Litres/min	Joint Type
0.040" 1.0mm	35-45 40-50	20-30 25-35	0.040" 1.0mm	1/16" 1.6mm	5-7	Butt/Corner Lap/Fillet
0.045" 1.2mm	45-55 50-60	30-45 35-50	0.040" 1.0mm	1/16" 1.6mm	5-7	Butt/Corner Lap/Fillet
1/16" 1.6mm	60-70 70-90	40-60 50-70	1/16" 1.6mm	1/16" 1.6mm	7	Butt/Corner Lap/Fillet
1/8" 3.2mm	80-100 90-115	65-85 90-110	1/16" 1.6mm	3/32" 2.4mm	7	Butt/Corner Lap/Fillet
3/16" 4.8mm	115-135 140-165	100-125 125-150	3/32" 2.4mm	1/8" 3.2mm	10	Butt/Corner Lap/Fillet
1/4" 6.4mm	160-175 170-200	135-160 160-180	1/8" 3.2mm	5/32" 4.0mm	10	Butt/Corner Lap/Fillet

Table 6-5

TIG Welding is generally regarded as a specialised process that requires operator competency. While many of the principles outlined in the previous Arc Welding section are applicable a comprehensive outline of the TIG Welding process is outside the scope of this Operating Manual. For further information please refer to www.cigweld.com.au or contact Cigweld.

6.04 TIG (GTAW) Welding Problems

FAULT	CAUSE	REMEDY
1 Excessive bead build up or poor penetration or poor fusion at edges of weld.	Welding current is too low	Increase weld current and/or faulty joint preparation.
2 Weld bead too wide and flat or undercut at edges of weld or excessive burn through.	Welding current is too high	Decrease weld current.
3 Weld bead too small or insufficient penetration or ripples in bead are widely spaced apart.	Travel speed too fast	Reduce travel speed.
4 Weld bead too wide or excessive bead build up or excessive penetration in butt joint.	Travel speed too slow	Increase travel speed.
5 Uneven leg length in fillet joint	Wrong placement of filler rod	Re-position filler rod.

FAULT	CAUSE	REMEDY
6 Electrode melts or oxidises when an arc is struck.	A Torch lead connected to positive welding terminal. B No shielding gas flowing to welding region. C Torch is clogged with dust or dirt. D Shielding gas hose is damaged. E Shielding gas regulator turned off. F The electrode is too small for the welding current.	A Connect torch lead to negative welding terminal. B Check the shielding gas lines for kinks or breaks and shielding gas cylinder contents. C Clean torch. D Replace shielding gas hose. E Turn On Shielding Gas and adjust Shielding Gas flow rate for the welding job. Refer to Table 6-5 on Page 6-6. F Increase electrode diameter or reduce the welding current.
7 Dirty weld pool	A Electrode contaminated by contact with work piece or filler rod material. B Work piece surface has foreign material on it. C Shielding gas contaminated with air.	A Clean the electrode by grinding off the contaminates. B Clean surface. C Check shielding gas lines for cuts and loose fitting or change shielding gas cylinder.
8 Poor weld finish	Inadequate shielding gas.	Increase shielding gas flow or check shielding gas line for shielding gas flow problems.
9 Arc start is not smooth.	A Tungsten electrode is too large for the welding current. B The wrong electrode is being used for the welding job. C Shielding gas flow rate is too high. D Incorrect shielding gas is being used. E Poor work clamp connection to work piece.	A Select the right size tungsten electrode. Refer to Table 6-1 Cigweld Tungsten Electrode Selection Chart. B Select the right size tungsten electrode type. Refer to Table 6-3 Cigweld Tungsten Electrode Selection Chart. C Select the right shielding gas flow rate for the welding job. Refer to Table 6-5 on page 6-6 D Select the correct shielding gas. E Improve connection to work piece.
10 Arc flutters during TIG welding.	Tungsten electrode is too large for the welding current.	Select the right size tungsten electrode. Refer to Table 6-1 Cigweld Tungsten Electrode Selection Chart.

Table 6-6: GTAW (TIG) Welding Problems

SECTION 7: ROUTINE SERVICE REQUIREMENTS AND POWER SOURCE PROBLEMS

7.01 Routine Maintenance & Inspection



WARNING

There are extremely dangerous voltage and power levels present inside this product. Do not attempt to open or repair unless you are a qualified electrical tradesperson. Disconnect the Welding Power Source from the Mains Supply Voltage before disassembling.

Welding equipment should be regularly checked by a qualified electrical tradesperson to ensure that:

- The main earth wire of the electrical installation is intact.
- Power point for the Welding Power Source is effectively earthed and of adequate current rating.
- Plugs and cord extension sockets are correctly wired.
- Flexible cord is of the 3-core tough rubber or plastic sheathed type of adequate rating, correctly connected and in good condition.
- Welding terminals are shrouded to prevent inadvertent contact or short circuit.
- The frame of the Welding Power Source is effectively earthed.
- Welding leads and electrode holder are in good condition.
- The Welding Power Source is clean internally, especially from metal filing, slag, and loose material. If any parts are damaged for any reason, replacement is recommended.

7.02 Cleaning the Welding Power Source



WARNING

There are extremely dangerous voltage and power levels present inside this product. Do not attempt to open or repair unless you are a qualified electrical tradesperson. Disconnect the Welding Power Source from the Mains Supply Voltage before disassembling.

To clean the Welding Power Source, open the enclosure and use a vacuum cleaner to remove any accumulated dirt, metal filings, slag and loose material. Keep the shunt and lead screw surfaces clean as accumulated foreign material may reduce the welders output welding current.



CAUTION

Do not use compressed air to clean the Welding Power Source. Compressed air can force metal particles to lodge between live electrical parts and earthed metal parts within the Welding Power Source. This may result in arcing between these parts and their eventual failure.

7.03 Basic Troubleshooting



WARNING

There are extremely dangerous voltage and power levels present inside this product. Do not attempt to open or repair unless you are a qualified electrical tradesperson and you have had training in power measurements and troubleshooting techniques.

If major complex subassemblies are faulty, then the Welding Power Source must be returned to an Accredited CIGWELD Service Agent for repair.

The basic level of troubleshooting is that which can be performed without special equipment or knowledge.

7.04 Welding Power Source Problems

Description	Possible Cause	Remedy
1 The welding arc cannot be established	A The Primary supply voltage has not been switched ON	A Switch ON the Primary supply voltage
	B The Welding Power Source switch is switched OFF	B Switch ON the Welding Power Source
	C Loose connections internally	C Have an Accredited CIGWELD Service Provider repair the connection
2 Over Temp Indicator is illuminated and unit will not commence welding.	Duty cycle of power source has been exceeded.	Leave the power source switched ON and allow it to cool. Note that Over Temp indicator must not be illuminated prior to commencement of welding.
3 Maximum output welding current cannot be achieved with nominal Mains supply voltage	Defective control circuit	Have an Accredited CIGWELD Service Provider inspect then repair the welder
4 Welding current reduces when welding	Poor work lead connection to the work piece	Ensure that the work lead has a positive electrical connection to the work piece
5 TIG electrode melts when arc is struck	A TIG torch is connected to the (+) VE terminal	A Connect the TIG torch to the (-) VE terminal
	B Incorrect Shielding Gas is being used.	B Ensure that Welding Grade Argon is being used.
	C Inadequate shielding gas flow or shielding gas not turned on.	C Turn on shielding gas and set shielding gas flow rate for the welding job. Refer to Table 6-5 on Page 6-6.
	D Incorrect Tungsten	D Check Tungsten type and change if necessary.
6 Arc flutters during TIG welding	Tungsten electrode is too large for the welding current	Select the correct size of tungsten electrode refer to Table 6-1 Cigweld Tungsten Electrode Selection Chart.

Table 7-1

SECTION 8: KEY SPARE PARTS

8.01 WeldSkill 140 Key Spare Parts

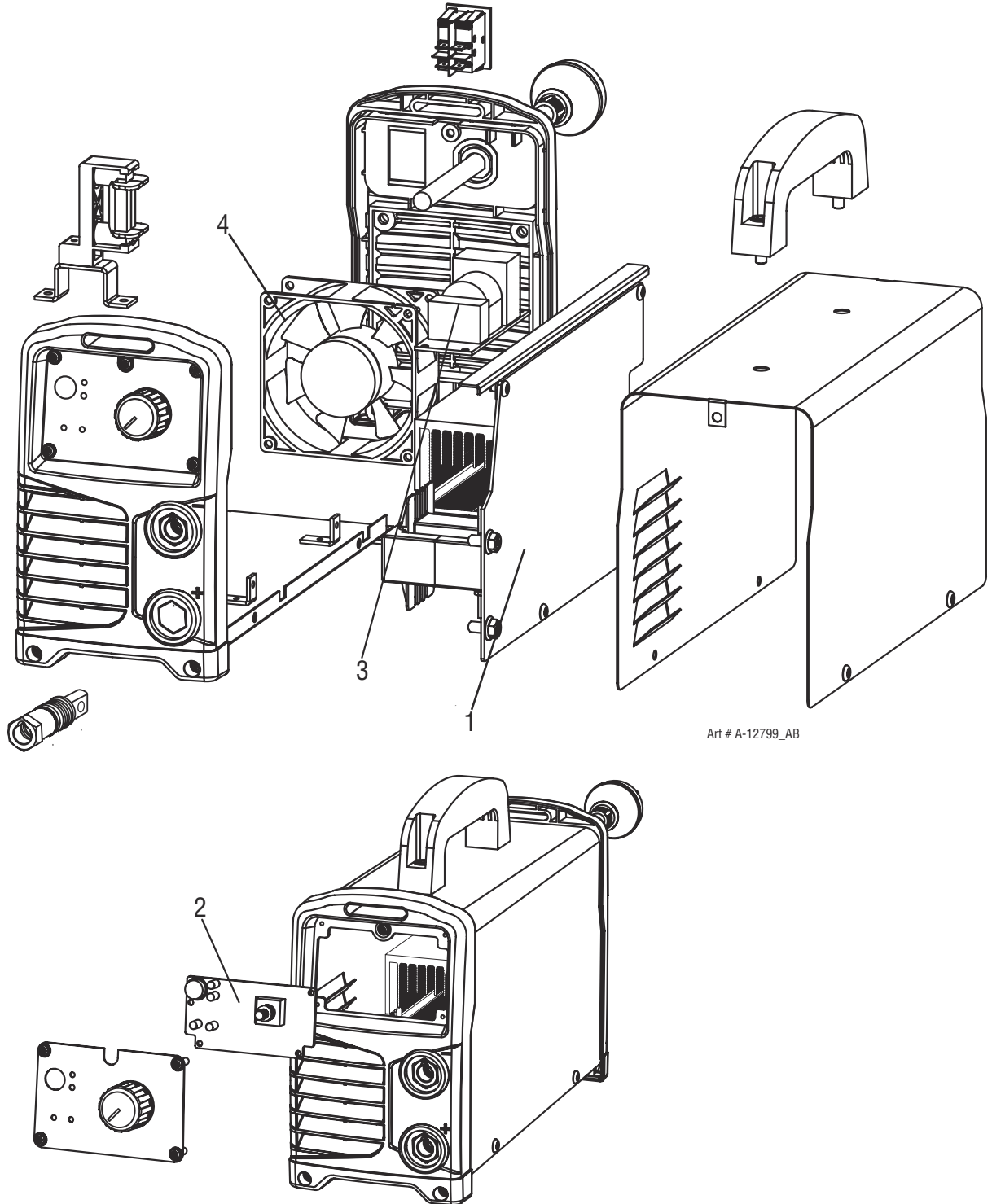
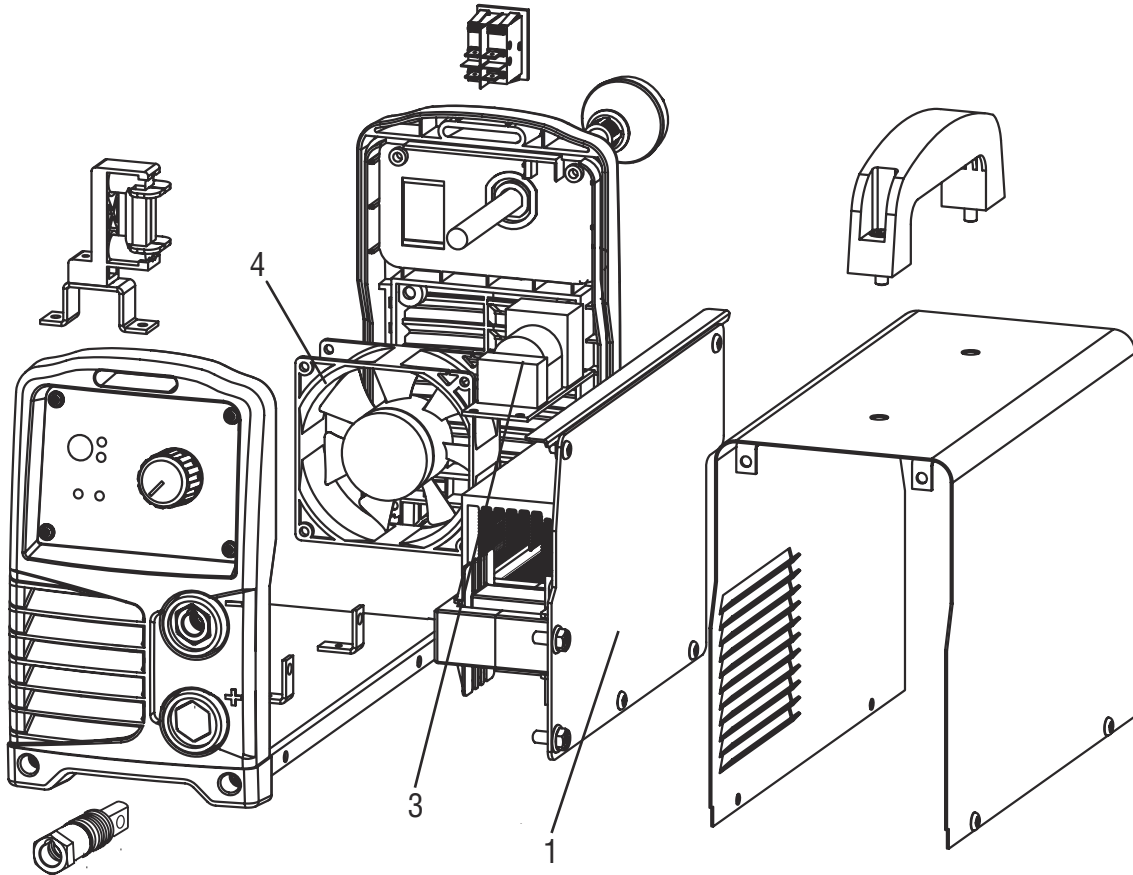

Figure 8-1

WELDSKILL 140 POWER SOURCE KEY SPARE PARTS		
ITEM	PART NUMBER	DESCRIPTION
1	W7006804	PCB Power Inverter
2	W7006805	PCB Front Panel
3	W7006806	PCB EMC Filter
4	W7006809	Fan Assembly

Table 8-1

8.02 WeldSkill 180 Key Spare Parts



Art # A-12800_AB

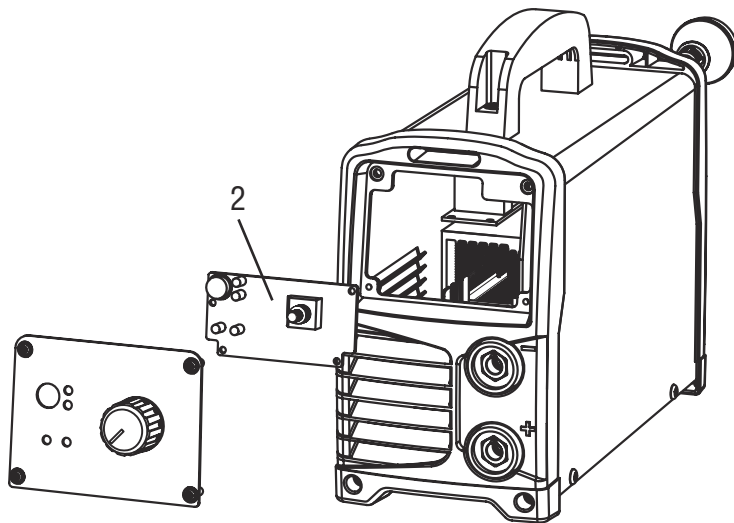

Figure 8-2

WELDSKILL 180 POWER SOURCE KEY SPARE PARTS		
ITEM	PART NUMBER	DESCRIPTION
1	W7006824	PCB Power Inverter
2	W7006825	PCB Front Panel
3	W7006826	PCB Primary Rectifier/EMC Filter
4	W7006809	Fan Assembly

Table 8-2

CIGWELD - LIMITED WARRANTY TERMS

LIMITED WARRANTY: CIGWELD Pty Ltd, An ESAB Brand, hereafter, "CIGWELD" warrants to customers of its authorized distributors hereafter "Purchaser" that its products will be free of defects in workmanship or material. Should any failure to conform to this warranty appear within the time period applicable to the CIGWELD products as stated below, CIGWELD shall, upon notification thereof and substantiation that the product has been stored, installed, operated, and maintained in accordance with CIGWELD's specifications, instructions, recommendations and recognized standard industry practice, and not subject to misuse, repair, neglect, alteration, or accident, correct such defects by suitable repair or replacement, at CIGWELD's sole option, of any components or parts of the product determined by CIGWELD to be defective.

CIGWELD MAKES NO OTHER WARRANTY, EXPRESS OR IMPLIED. THIS WARRANTY IS EXCLUSIVE AND IN LIEU OF ALL OTHERS, INCLUDING, BUT NOT LIMITED TO ANY WARRANTY OF MERCHANTABILITY OR FITNESS FOR ANY PARTICULAR PURPOSE.

LIMITATION OF LIABILITY: CIGWELD SHALL NOT UNDER ANY CIRCUMSTANCES BE LIABLE FOR SPECIAL, INDIRECT OR CONSEQUENTIAL DAMAGES, SUCH AS, BUT NOT LIMITED TO, LOST PROFITS AND BUSINESS INTERRUPTION. The remedies of the Purchaser set forth herein are exclusive and the liability of CIGWELD with respect to any contract, or anything done in connection therewith such as the performance or breach thereof, or from the manufacture, sale, delivery, resale, or use of any goods covered by or furnished by CIGWELD whether arising out of contract, negligence, strict tort, or under any warranty, or otherwise, shall not, except as expressly provided herein, exceed the price of the goods upon which such liability is based. No employee, agent, or representative of CIGWELD is authorized to change this warranty in any way or grant any other warranty.

PURCHASER'S RIGHTS UNDER THIS WARRANTY ARE VOID IF REPLACEMENT PARTS OR ACCESSORIES ARE USED WHICH IN CIGWELD'S SOLE JUDGEMENT MAY IMPAIR THE SAFETY OR PERFORMANCE OF ANY CIGWELD PRODUCT. PURCHASER'S RIGHTS UNDER THIS WARRANTY ARE VOID IF THE PRODUCT IS SOLD TO PURCHASER BY NON-AUTHORIZED PERSONS.

The warranty is effective for the time stated below beginning on the date that the authorized distributor delivers the products to the Purchaser. Notwithstanding the foregoing, in no event shall the warranty period extend more than the time stated plus one year from the date CIGWELD delivered the product to the authorized distributor.

Any claim under this warranty must be made within the warranty period which commences on the date of purchase of the product. To make a claim under the warranty, take the product (with proof of purchase from a Cigweld Accredited Seller) to the store where you purchased the product or contact Cigweld Customer Care 1300 654 674 for advice on your nearest Service Provider. CIGWELD reserves the right to request documented evidence of date of purchase. CIGWELD or our Accredited Distributor must be notified in writing of its claim within seven (7) days of becoming aware of the basis thereof, and at its own expense returning the goods which are the subject of the claim to CIGWELD or nominated Accredited Distributor/Accredited Service Provider

This warranty is given.

Cigweld Pty Ltd

A.B.N. 56007226815

71 Gower Street, Preston

Victoria, Australia, 3072

Phone: 1300 654 674

Email: enquiries@cigweld.com.au

Website: www.cigweld.com.au

This warranty is provided in addition to other rights and remedies you have under law: Our goods come with guarantees which cannot be excluded under the Australian Consumer Law. You are entitled to replacement or refund for a major failure and to compensation for other reasonably foreseeable loss or damage. You are also entitled to have the goods repaired or replaced if the goods fail to be of acceptable quality and the failure does not amount to a major failure.

Please note that the information detailed in this statement supersedes any prior published data produced by CIGWELD.

WARRANTY SCHEDULE – WeldSkill 140 & 180 Inverters

WARRANTY	WARRANTY PERIOD – (Parts and Labour)
WeldSkill 140 and 180 Inverter Power Source	3 Years
Electrode Holder Lead and Work Lead	3 Months

CIGWELD Limited Warranty does not apply to;

- Obsolete goods sold at auction, second-hand goods and prototype goods.
- Consumable Parts for MIG, TIG, Plasma welding, Plasma cutting and Oxy fuel torches, O-rings, fuses, filters or other parts that fail due to normal wear.

Note:

* No employee, agent, or representative of CIGWELD is authorized to change this warranty in any way or grant any other warranty, and CIGWELD shall not be bound by any such attempt. Correction of non-conformities, in the manner and time provided herein, constitutes fulfilment of CIGWELD's obligations to purchaser with respect to the product.

* This warranty is void, and seller bears no liability hereunder, if purchaser used replacement parts or accessories which, in CIGWELD's sole judgment, impaired the safety or performance of any CIGWELD product and if the unit is altered or serviced by an unauthorised CIGWELD Service Provider. Purchaser's rights under this warranty are void if the product is sold to purchaser by unauthorized persons.

This Page Intentionally Blank



CIGWELD Pty Ltd
CIGWELD An ESAB Brand
71 Gower Street, Preston VIC 3072 Australia

Customer Care:
Tel: 1300 654 674 | Fax: 03 9474 7391
Email: enquiries@cigweld.com.au

International Enquiries
Tel: +61 3 9474 7508 | Fax: +61 3 9474 7488

Malaysia -
Lot 151, Jalan Industri 3/5A
Rawang Integrated Industrial Park,
Jln Batu Arang
48000 Rawang Selangor Darul Ehsan
West Malaysia

Tel: 60 3 6092 2988 | Fax: 60 3 6092 1085

Indonesia -
JL Akasia II Blok A-05 No. 10A
Delta Silicon - Lippo Cikarang
Bekasi, 17550
Indonesia

Toll Free: 0 800 1842 867
Tel: +62 21 8990 6095 | Fax: +62 21 8990 6096